

**(ELECTROPLATING AND EFFLUENT TREATMENT)**



**EXERCISE 1 –****3HRS**

**OBJECTIVE:** The objective of this exercise is to understanding the different symbols associated with electricity used in electroplating study.

**THEORY:** Common electrical symbols and term, with their meanings.

<u>Symbols</u>	<u>Meaning</u>
<b>DC (Direct current)</b>	: The only current used electro-plating purposes.
<b>AC (Alternating current):</b>	The current coming from utility or supply.
<b>V (Volts)</b>	: It represents the current pressure or force.
<b>A</b>	: Amperes represents the volume or quantity of Current.
<b>W (Watts)</b>	: = $V \times A$ . It is a measure of power.
<b>K W (Kilowatt)</b>	: = $W \times 1000$ (one thousand watts)
<b>EMF</b>	: Electro-motive force of voltage.
<b>P or +</b>	: Positive pole or line conducting current from line/battery
<b>N or -</b>	: Negative pole or line conducting return
<b>H P</b>	: Horse power (unit of power) 1HP = 746watts
<b>RP M</b>	: Revolutions per minute
<b>Cathode</b>	: The article to be plated or deposited upon.
<b>Generator</b>	: A machine that converts electrical energy (current) into mechanical energy (current into motion)
<b>Motor</b>	: A machine that converts electrical energy (current) into mechanical energy (current into motion)
<b>Neutral</b>	: A conductor used for convenience and economy through which the current may flow in either direction.
<b>Potential</b>	: The difference of electrical conditions.
<b>Rheostat</b>	: A current regulator (variable resistor)
<b>Short circuit</b>	: A path of little or no resistance, connecting positive and negative conductors.
<b>Voltmeter</b>	: An instrument for indicating the current pressure / voltage

**Ammeter** : An instrument for indicating the volume or quantity of current / ampere.

**Circuit** : The path in which the current flows.

**Ground** : The connection of any part of an electrical current with the earth, either by fault or by intention. A ground is used in some circuits for economy, but is to be avoided in electro-plating circuits.

**METHODOLOGY:** The study can be divided into following steps.

Step 1: Take 3 incandescent bulbs of different ratings used in houses. See the rating and tabulate it.

VOLTAGE (V)	CURRENT (A)	POWER (W)

Step 2: Take a voltmeter, an ammeter and a wattmeter. Find the measuring ranges of these devices and tabulate it.

VOLTMETER RANGE	AMMETER RANGE	WATTMETER RANGE

Step 3: Go to an electroplating shop and study all electrical parameters responsible and their symbol as well.

**LAB EXERCISE 2-****3 HRS**

**OBJECTIVE:** The aim of this study is to have an understanding of different types of electrical measuring devices used in electroplating.

**THEORY:** It is a fundamental law of electrolysis that a certain number of amperes passing through a plating solution will cause a definite weight of metal to be deposited so by means of an accurate ammeter the amount of metal actually deposited can be determined.

There are mainly three types of measuring instruments used in electroplating process namely voltmeter, ammeter and wattmeter. Voltmeter is used to measure voltage, ammeter is used to measure current and wattmeter is used to measure power in an electrical circuit. Different types of voltmeter and ammeter are available for AC and DC purpose. We are concerned about only DC voltmeter and DC ammeter. Figure below shows a simple electrical circuit to understand the operation of these devices. Ammeter is connected in series and voltmeter in parallel always.

**Ammeter:** An ammeter connected in the main line circuit will register the volume of quantity of current generated by the dynamo. An ammeter connected in series with tank will register only the quantity of current going into the tank. Standard ammeters reading up to about 200 amperes are generally self contained; those reading higher are furnished with an external shunt.

Main line ammeter should be connected in the negative main line between the dynamo and first tank branch line. Individual tank ammeter should be connected in the negative branch line between the tank and tank rheostat.

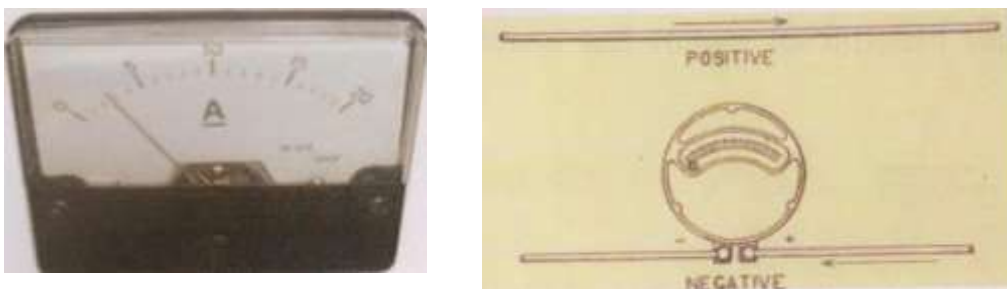

Fig. Ammeter and its connections

**Voltmeter:** Maintaining proper voltage across anode and cathode is necessary for proper electroplate deposition. Voltages are measured with the help of voltmeter. Voltmeters are connected in parallel with cathode and anode.

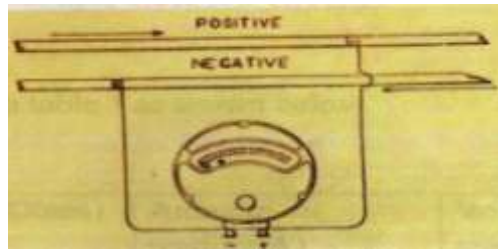

Fig. Voltmeter and its connections

**Methodology:** This study can be done by following steps

Step 1: Take batteries of 3V, 6V and 12V

Step 2: Take a resistance of 10 OHMS

Step 3: Take a voltmeter of 20V range and ammeter of 1A range

Step 4: Connect the circuit as shown in the figure below

Step 5: Measure the value of current and voltage for different values of battery voltage.

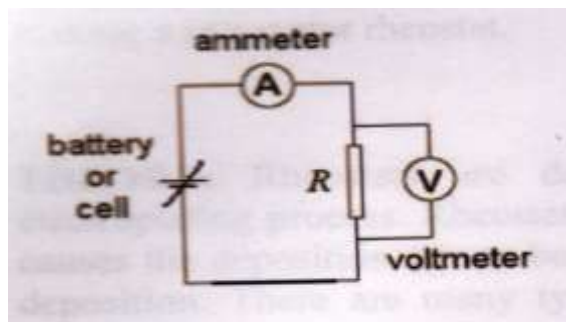

Fig. Schematic circuit diagram of simple electrical circuit.

Result: Tabulate the result in table 1 as shown below.

TABLE 1

Battery voltage	Resistance (Ohms)	Ammeter reading (A)	Voltmeter reading (V)

**EXERCISE 3 –****10 hrs**

**OBJECTIVE:** The aim of this study is to understand the concept of resistance and making a salt water rheostat.

**THEORY:** Rheostats are devices which are used to control current in electroplating process. Rheostats are variable resistances. High value of resistance causes the deposition rate to be slow down. Low value of rheostat speeded up the deposition. There are many types of rheostat available in the market. But for electroplating we can make our own salt water rheostat.

**METHODOLOGY:** A simple rheostat can be an excellent inexpensive addition to a miniature plating workshop. The following design works well for controlling 10 amps – 100+amps.

Obtain a suitable plastic container as a tank, approx 10''x15'' x 10'' deep. Cut 2 sheets of copper galvanized sheet metal, brass or lead to fit on one side of the tank. The thickness of the sheet is not important, so long as it is fairly rigid. Attach a piece of wooden batten to the top edge of both pieces of metal with screws. The batten should be long enough to rest across the tank top, so as to suspend the plate into the liquid. Attach a wire to each sheet, making sure you have a good electrical connection. One wire from one plate should connect to the positive side of your battery, the other to the anodes. You may fix one plate to the side of the tank so that it does not move. Also secure a large piece of plastic rain gutter mesh. This will stop the two plates touching each other and shorting out.

Salt water rheostat are ideal for one off, short run setups. Their disadvantage is that the water heats up and so the resistance changes. This problem can be reduced by making a large tank, so the greater quantity of water takes longer to heat, or by cooling the water by a simple heat exchanger made from a coil of garden hose placed in the bottom of the tank, with cold water running through it.

**OPERATION:** To operate fill the tank with fresh water. Pour in approx 1 pound of salt, and stir to dissolve. You may alter the concentration of salt to achieve different results. By adding more salt you will increase the amperage range.

**CONTROLLING THE RANGE:** Slide the movable plate to alter the resistance. The further apart the two plates are the less current flow will occur. If you discover during your operation, you don't have enough resistance from the salt water rheostat, simply remove some of the salt water and replace with fresh, thus decreasing the conductivity. In the picture, left lead sheet has been used for the plates. This has been wrapped over a short length of copper tubing. The tank is a plastic window box. During continual use, the water temperature in the tank may rise and this will affect the resistance. You may have to make an occasional adjustment to maintain the same setting during long plating episodes with high amperages.

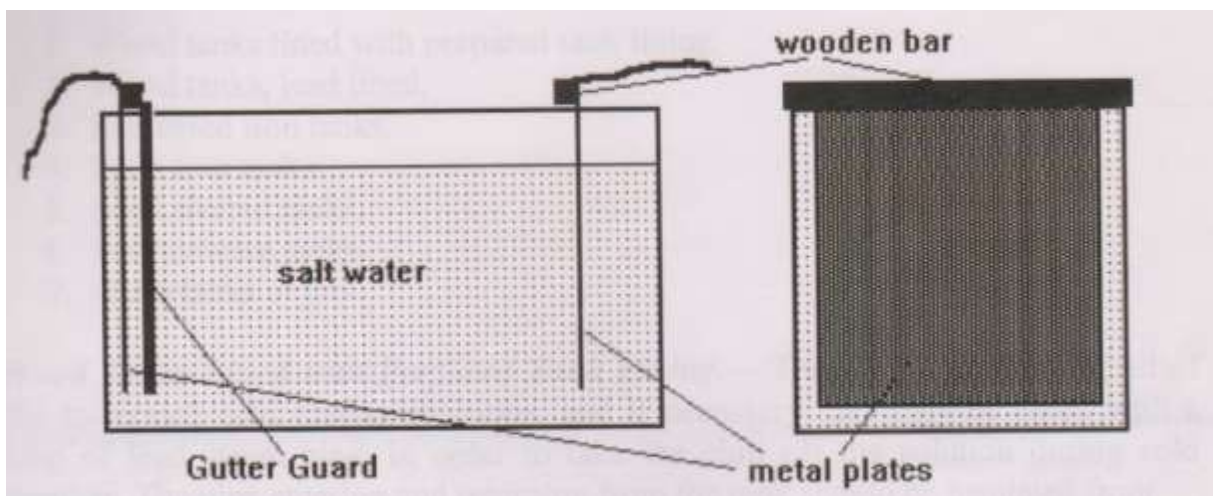

**Fig. Salt water rheostat**

**EXERCISE 4 –****8 hrs**

**OBJECTIVE:** The aim of this exercise to give the concept of tanks used in electroplating. This exercise also discusses different types of tanks and its manufacturing procedures.

**THEORY:** Tanks for plating solutions are made of several kinds of materials. The kind required depending upon the kind and quantity of solution to be used. The regular tanks are:

1. Wood tanks lined with prepared tank lining.
2. Wood tanks, lead line.
3. Enamelled iron tanks.
4. Plain iron tanks.
5. Steel riveted tanks.
6. Earthenware tanks.
7. Glass tanks or jars.

**Wood Tanks lined with prepared tank lining –** These may be used for all of the so-termed cold plating solutions, and if necessary they may be fitted with a loop of lead steam pipe, in order to take the chill off the solution during cold weather. The pipe entering and returning from the tank should be insulated from the heating system with insulating joints. However must be taken that the solution does not become too hot, as this will cause the lining to run to the bottom of the tank. In no case should the temperature exceed 120degree F. Wood tanks are generally used when it is necessary to operate large plating solutions, they serve a very good tank. Tanks or tubes that are to be used for acid dips or pickles should be lined both inside and outside but not sanded, as the action of the acid would soon destroy the sand.

**Wood Tanks, Lead Lined –** These tanks while the most expensive, make the best possible containers for all plating solutions, either cold or hot. It is better to have the lead coated with prepared tank lining. These tanks are particularly recommended for silver and acid copper solutions.

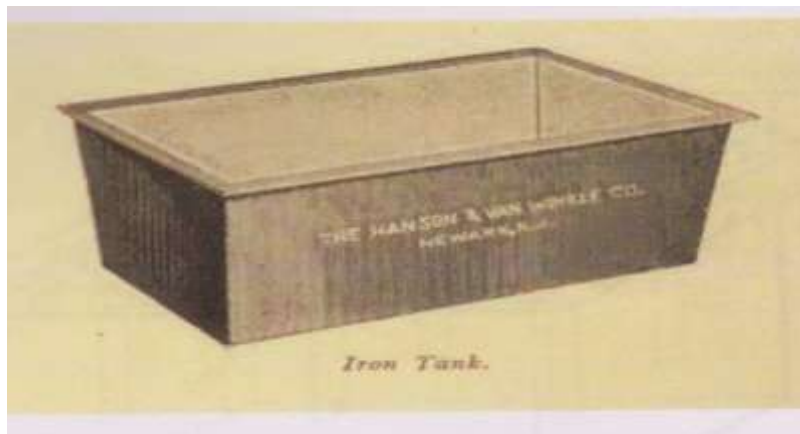

**Fig. Wood Tank**



**Enamelled Iron Tanks** – These may be used with all solutions, either cold or hot, excepting acid or acid solutions, for the reason that the action of the acid will quickly destroy the enamel. They are particularly adapted for use with gold and silver solutions.

**Plain Iron Tanks** – These may be used for cyanide solutions, either cold or hot, excepting gold, silver, galvanizing, acid copper or nickel solutions, but when lined with prepared tank lining they will serve the same purpose as the wooden tanks. The plain and enamelled iron tanks are generally made with an overhanging flange of about one inch. A good plan for supporting these is to make a frame of boards about 6 inches wide, built on edge, on which the tank flanges may rest. Suitable legs of the desired height can then be fastened to the frame. When fitting anode and cathode rods on iron tanks, they must be insulated from the tank. This may be done by using wooden strips placed across the ends of the tanks, or by fitting a small piece of rubber hose over the rods.



**Fig. Iron Tank**

**Steel Riveted Tanks** – These may be used under the same conditions as the plain iron tanks.

**Earthenware Tanks** – These may be used for all solutions, either cold or hot but care must be taken while heating the solutions to do so gradually in order to prevent the tank from cracking. When used for hot solutions it is safer to arrange the tank in a steam-heated water jacket or bath.

**Glass Tanks or Jars** – These may be used for all solutions and are particularly adapted for use with small gold and silver solutions. If a hot solution is to be used it should be heated gradually in order to prevent the glass from cracking. When heating solutions contained in glassware they should be placed on a sand bath (an iron pan containing sand) as they may be heated more evenly in this manner,



**EXERCISE 5.****5 HRS**

**OBJECTIVE:** The aim of this study is to understand different power sources for electroplating process.

**THEORY:** There are mainly three types of current sources used for electroplating namely.

1. Dynamo
2. Battery
3. Rectifier

**DYNAMO:** Dynamo is a device which produces a DC voltage and DC current by rotating its shaft. Its shaft may be rotated with the help of a diesel generator set. Generally producing DC current by Dynamo is a outdated technology.



**Fig. Dynamo connected with a diesel generator set.**

**BATTERY:** Giving pure 'ripple free' DC current, batteries are the obvious preferred choice of power source, and are able to supply high ampere for a short duration, ideal for chroming small parts. As the usual current requirements are 2-6 volts for most plating jobs, it is preferable to use a 6 volts supply. By using 12 volts, we have more difficulty in disposing of the additional heat. Much larger rheostats are required. So it makes more sense when designing your system to use the correct voltage in the first place.



**Fig. Different types of Batteries**

There are two types of batteries. One which can be recharged again after discharged and second which can't be recharged again after use or discharge. It is a use and through type figure below shows a typical charging connection.

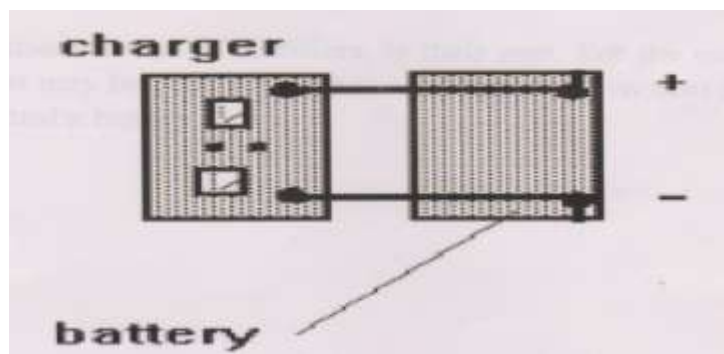

**Fig. Charger and Battery connections**

**RECTIFIER:** It is an electrical device which gives a controlled DC current. It takes supply from the utility (AC power). Rectifiers are available of different ratings.



**Fig. Rectifier of 200 A rating.**

This unit (fig) will plate chrome parts up to approx 200 sq. Inches in surface area. It is not suitable for plating small parts less than 20 square inches, or for any other type of small item plating, because the lower end of the 'tuning' range is simply not fine enough to give you an accurate result. For these parts use the 25 amp rectifier.

The only disadvantage of rectifier, is their cost. For the occasional plating job, the initial cost may be prohibitive. So an alternative low cost method is to use light bulbs to control a battery.

**EXERCISE 6.****3 HRS**

**OBJECTIVE:** The aim of the exercise is to understand the concept of series and parallel combination of resistance and cell and understanding the method of increasing the voltage and current rating of power devices.

**THEORY:** In series combination of resistance, the equivalent resistance of combination will be added up and become more than the highest of them. In parallel combination of resistance the equivalent resistance will become less than the lowest of them.

Series combinations of cells are used to increase the voltage rating. The equivalent voltage will be added up in series combination. Parallel combinations of cells are used to increase the current rating. Voltage rating remains same and current rating increases in parallel combination of cells.

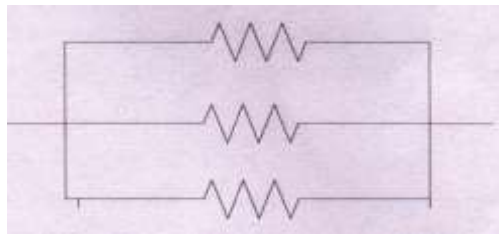

**Fig. Parallel combination of three resistances**



**Fig. Series combination of three resistances**

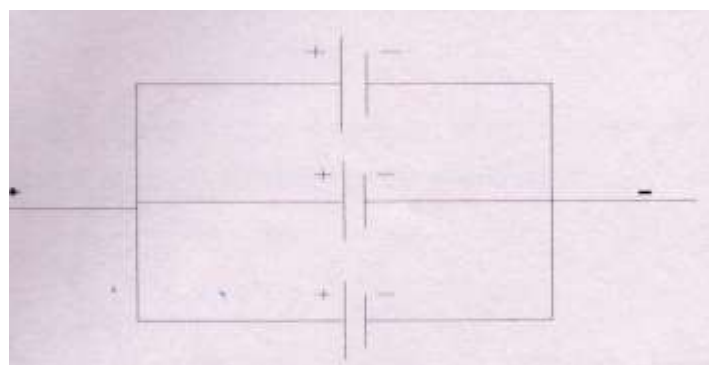

**Fig. Parallel combination of three cells**

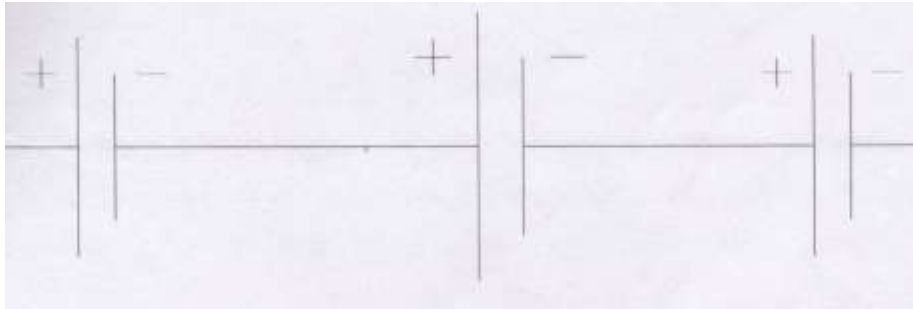

**Fig. Series combination of three cells**

**PROCEDURE:** Make a simple resistive circuit. Use the series and parallel combination of resistances instead of one resistance and measure the value of voltage and current. In the same circuit use the combination of cells instead of single and measure the value of voltage and current.

**EXERCISE 7.****5 HRS**

**OBJECTIVE:** The aim of this exercise is to study the law which governs the quantity (mass) of material electroplated on the work-piece.

**THEORY:** electroplating follows

$$**$m = Z \cdot I \cdot t$**$$

The amount of mass stuck (thickness of plating) during electroplating process depends on various parameters. These parameters are: Z (molar mass and it is fixed for a particular metal), I (the amount of current) and t (the time up to which work is in the solution with current flowing through it).

It is concluded from above study that the thickness of electroplating is proportional to the amount of current and the duration of electroplating. Increasing either will increase the thickness of metal on the work piece.

**METHODOLOGY:** Take simple electroplating problem, say copper electroplating. First fix the current and observe the thickness of plating by varying time. Secondly vary the amount of current by using rheostat. See the thickness of plating for a fixed period of electroplating duration. Note the observation.



**EXERCISE 8.****10 HRS**

**OBJECTIVE:** The aim of this exercise to provide a systematic way to make a work piece able to be plated.

**PROCEDURE:** Surfaces to be plated must be clean and free from rust and scale.

To clean work prior to plating, the following general procedure will be sufficient in most cases:

1. Degrease work surface thoroughly using a commercial vapour degreaser, acetone or lacquer thinner.
2. Scour all the surfaces with 'soft scrub household abrasive cleaner' or vim
3. Rinse work thoroughly in clean water and plate immediately
4. Do the water break test. Continuous water films are a good indication of properly cleaned surfaces. Immerse work in water and look for an even distribution of water film on the surface to be plated. Droplets or surfaces where water will not adhere will indicate an oily surface not suitable for plating.

Commercial oxides and those resulting from nitriding of tools or parts and / or other stubborn surface impurities can be most effectively removed by immersion in a solution of 25% (by vol.) muriatic acid for 15 minutes followed by a cold water rinse before plating. Care must be taken not to destroy cutting edges or fine base metal finishes by too prolonged or serves treatment. A cold water rinse should draw dies, etc. requires that special cleaning procedures be followed so as not to damage the mirror like finish. Stripping or serve etching procedures are not recommended.

If for any reason the already cleaned work surface cannot be plated immediately after cleaning, immersion in SP degreaser will prevent oxidation of the cleaned surface. The work can then remain in the atmosphere up to periods of an hour or less. When ready for plating, parts should be rinsed in clean water and plated.

**EXERCISE 9.****3HRS**

**OBJECTIVE:** The aim of this exercise is to understand the concepts and procedure of pre-processing of work piece and make it suitable for plating purpose.

**THEORY:** Buffing and polishing using wheels and compounds is somewhat like using wet and dry sanding paper, only much faster. Instead of using 'elbow grease' you will be using the power and speed of an electric motor. The edge, or face, of the wheel is the 'sanding block', which carries a thin layer of compound which is the sandpaper. Varying types of wheel are available, and the different grades of compound are scaled similar to sandpaper. The compounds are made from a wax substance which has the different abrasive powders added to it. When this hard block is applied to the edge of a spinning buffing wheel, the heats from a friction melts and waxes, and both wax and abrasive are applied in a thin slick to the face of the wheel. The objective of buffing and polishing is to make a rough surface into a smooth one and, of course, each work piece will be a different condition, so will need different procedures. Imagine the surface magnified thousands of times; it will look like jagged mountains and valleys. By repeated abrasion, you are going to wear down those mountains until they are old, soft, rolling hills! Then they will not dissipate the light, but reflect it. It is the reflection that makes the buffed part appear shiny.

The actual compound does work, not the buffing wheel. Compounds are made from a mixture of fine abrasive fillers and a sort of greasy wax. The compound is melted, by friction heat, as the bar is pressed to the revolving wheel. This applies a thin layer of abrasive, 'glued' on to the cloth wheel, making it similar to an emery paper, only much faster.

**PROCEDURE:** Apply the work piece on the wheel of machine applied with the compound. Do not apply the compound after the work piece, or on its own. This wastes material and is much less efficient. By applying the material before the work piece, you actually use the work piece to force the compound in to the buff. This is much less wasteful, more efficient and will actually speed up your buffing times. Apply small quantities of compound, by approx ½ -1 second applications to the wheel.



Buffing and polishing machines can be mounted on a bench or a pedestal. These motors are especially made for buffing, grinding and polishing. They operate at 3450 rpm. and come in various sizes, depending on the job requirement. The one shown left is the  $\frac{3}{4}$ hp caswell buffer. A 2hp model is also available. A bench grinder can easily be converted to a buffing machine by the use of shaft extenders.

Remove the guards and slide the extender over the shaft and tighten the two grub's screws. You may need to turn the shafts extender a quarter turn and retighten after running the machine, to ensure the shaft is running true. Shaft extenders are made with right and left hand threads. So you need one of each for a bench grinder.



There are two types of buffing motion obtained. One that is used for cut and another that is for colour called colour motion.

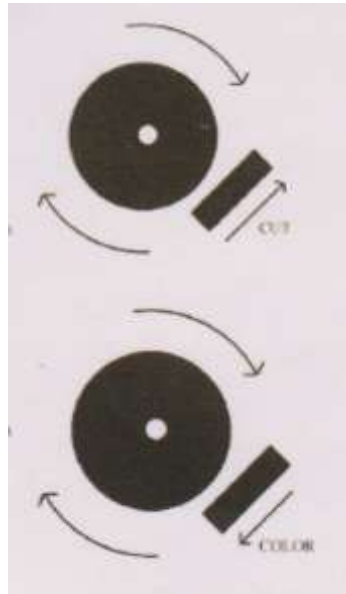

**EXERCISE 10.****10 HRS**

**OBJECTIVE:** The aim of this exercise to study the procedure of copper plating.

**THEORY:** Copper is a highly malleable and ductile red metal very largely used in the industrial arts. It does not resist the action of acids, and even moisture effects it, causing it to form an oxide known as verdigris; this under the action of carbonic acid, turns to green copper carbonate. Copper will also enter in to fine pinholes and cracks, and stop them., although copper can be easily deposited from an alkaline solution, it requires some amount of skill to deposit the metal in a tough condition fit for burnishing.

**PROCEDURE FOR SOLUTION:** First step towards copper electroplating is making solution for copper plating. Various solutions have been used for copper plating but the most successful one is explained below. Following materials are required for making solution for copper plating.

Copper sulphate,	4 oz.
Potassium cyanide,	12 oz.
Liquid ammonia,	4 oz.
Rainwater,	4 gal.

Dissolve 1 lb. of copper sulphate in  $\frac{1}{2}$  gal. of rain water, then stir in enough liquor ammonia to throw down the copper in the form of a green precipitate, and dissolve this to make a blue liquid. Dilute this with an equal bulk of rainwater, then add sufficient potassium cyanide to destroy the blue tint and produce the colour of old ale. Filter the whole through calico and expose to the action of air for twenty four hours, when it should be ready for use. Work it cold or hot.

Anode plates of pure copper must be employed. If the plates do not dissolve freely, but become encrusted with a green slime, a small quantity of potassium cyanide and of liquid ammonia should be added to the solution. The best electrodeposited pure copper should be selected for anode plates. Discarded Daniell battery plates will serve the purpose very well. Too little anode surface may result in a hard, dark deposit of copper, if the tension of the current is high. Too much anode surface may result in a loose, soft deposit of copper, which will peel off when scratch brushed. This may be remedied by alerting the resistance board, and interposing a higher resistance in circuit.

Too much anode surface tends to make the solution rich in copper, and this condition also favours a rapid deposit, which may be loose under certain other conditions, such as too much free cyanide and too much current.

**PLATING PROCEDURE:** Each article must be attached to a short length of copper wire, which suspends it in the vat. Each article should be held by the slinging wire during the final rinse, and the free end of this wire is bent over a brass rod on the plating vat, attached to the negative pole of the generator. Move each article to end from with a rinsing movement when placing it in the vat, to remove any air bubbles on the surface. The current should be regulated by a resistance, usually a long length of German silver wire furnished with a switch. The resistance can also be increased by diminishing the surface of the anode exposed to the plating solution, and by placing the anode further from the article being plated.

If the current is too strong, the deposited copper will be dark in colour and loose in character, and this will also happen if the solution contains too much copper. Movement of the articles whilst being plated will assist in securing a bright and smooth deposit. Some gas is given off from the articles whilst deposition is going on, but this should be regulated by adjusting the current. Only a few minutes is required for plating each article. The plated article should be rinsed in plenty of clean water to free them from cyanide and copper salts.

If the surface is to remain coppery, the articles should be rinsed in hot water, placed at once in hot bran or hot sawdust, and moved about in it until quite dry and bright. Pure copper readily tarnishes in the air when damp, but may be brightened with a scratch brush.

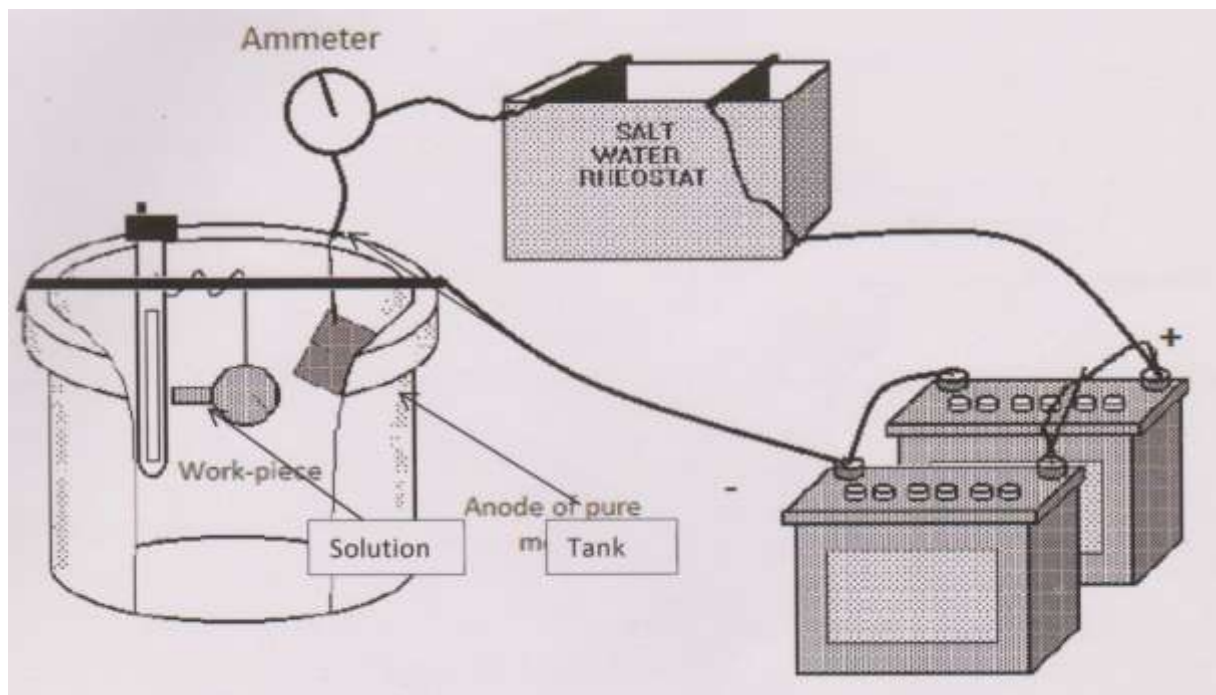

**EXERCISE 11.****10 HRS**

**OBJECTIVE:** The objective of this exercise is to understand the concept behind zinc electroplating or detailed procedure for zinc electroplating (galvanizing)

**THEORY:** Galvanizing is a process of zinc electroplating on cheap metal like iron etc. Galvanizing is used to protect the iron from rusting.

**PROCEDURE:** Like other electroplating processes, galvanizing starts with making a solution for galvanizing. The galvanizing solution can be made as follows:

<b>Water</b>	<b>1 gallon</b>
<b>Galvanizing salts</b>	<b>2 pounds</b>
<b>Toning salts</b>	<b>1 ounce</b>

When used as a still solution the voltage should be about 2.4 to 3 volts. When used as a plating barrel solution the current density should be from 6 to 10 volts. Use only pure zinc anodes. Dissolve all of the galvanizing salts in the full quantity of water required. Dissolve the toning salts in a portion of this solution, and then stir it in the bulk of the solution.

Pure zinc anodes should be suspended in the solution and allowed to remain overnight. Then skim and the solution will be ready for use. The toning salts should first be dissolved in a portion of the solution. If after considerable use, the solution stands below 18° Baume, add galvanizing salts to bring it up to the proper points. It is of first importance that the work should have a clean, metallic surface free from grease, rust and scale; otherwise good results cannot be obtained. Grease and dirt can be removed by immersing the work in a Kostico dip: 1 gallon of water, 8 ounce Kostico. This must be used at boiling point. Hard scale, sand and rust can be removed: 15 parts of water, 1 part muriatic acid. Use hot at 115 to 120° Fahr. This dip will remove light scale and rust.

Work that is plated in a still solution will have a very white and frosty appearance. It can be easily brightened by giving it a slight scratch brushing. Work that is plated in a mechanical plating barrel will not have the frosty appearance, as the rolling motion imparted to it causes a burnishing effect while the deposit is going on, which will frequently cause it to come from the barrel in a fairly bright condition, depending on the class and shape of the work. A good deposit should be obtained in a still solution in about 0.75 hour and a very heavy deposit in about



1 hour. A good deposit in a mechanical plating barrel solution requires from 1.5 to 2 hours. These figures are approximate only and for ordinary cases under proper conditions. The actual length of time of deposit depends on the class of work and the thickness of deposit required.

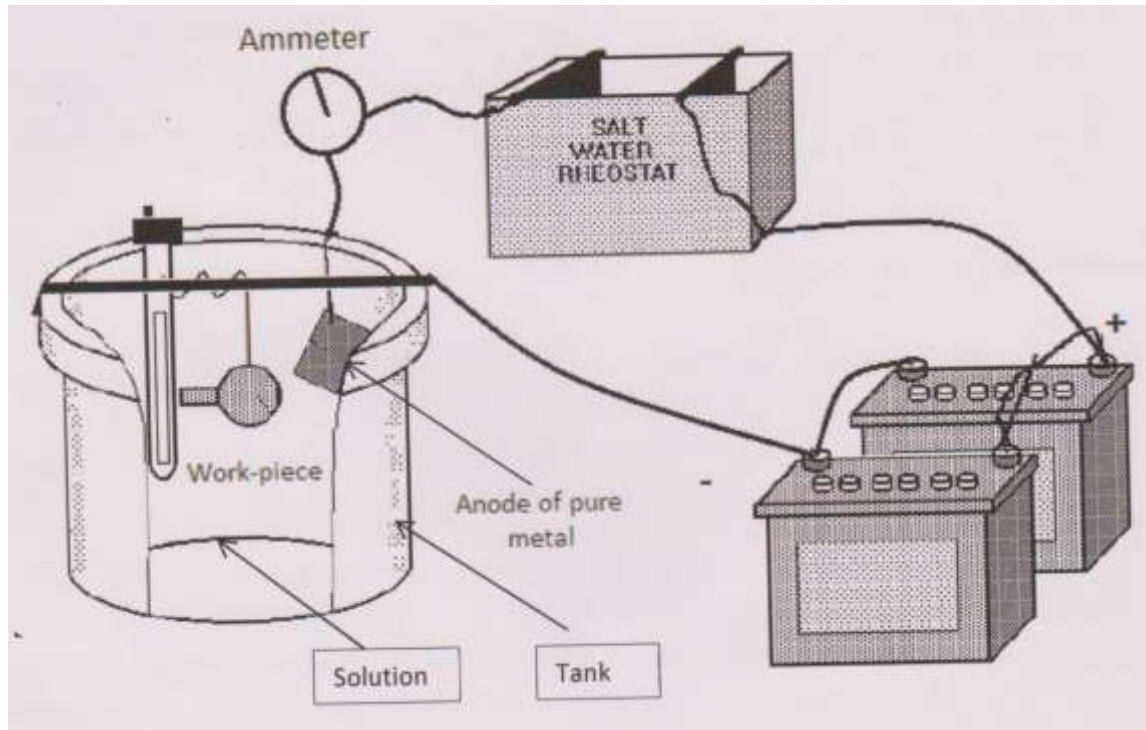

**EXERCISE 12.****10 HRS**

**OBJECTIVE:** THE AIM OF THIS EXERCISE IS TO STUDY THE PROCESS OF TIN PLATING AND TO GIVE A CONCEPT OF TIN ELECTROPLATING.

**THEORY:** This is a bright, shiny material and has excellent soldering capabilities making it ideal for all electrical connections applications. Tin is a very commonly used metal for the protection of steel. It is used extensively in the food trade because of its non toxic qualities. Tin plating can be plated directly over, copper, steel, brass, and bronze. Other more difficult metals such as pot metal. Average thickness is typically 0.0002 – 3 inches could achieved. Copper cook ware is often lined with tin. Usually molten tin is hand wiped into the cleaned pot. However lining can be done quite easily by the electroplating technique.

**PROCEDURE:** The very first step towards tin plating involves making a solution for tin plating. It can be made by mixing 3 quarts of battery acid into 6 quarts of distilled water, then adding one of tin concentrate.

Clean the inside of the pot thoroughly with an abrasive cleaner such as soft scrub. Buff and polish to an acceptable shine. Fill the pot to the brim with pickle # 2 and let soak until the entire inside ia a pink colour. Rinse thoroughly in hot water. Fill the pot to the brim with tin plating solution which has been preheated approx to 80 degrees.

Make a suitable tank bar from plastic or some other non conductor. Connect the positive wire from your power supply to the tin anode and the negative to the work piece/cooking pot. Then plate in the normal manner. The pot should keep the liquid around the optimum operating temp. of 72 degree F, especially if the start up temperature is raised to 80 degree far. Here are some parameters tabulated for good tin plating.

Tank type	Non conductor
Solution temp. range	65-80 degree F opt = 72 degree F
Plating time (minutes)	20-30
Anode	Tin
Cathode	Work piece
Milli amperes required per square inch	0.1

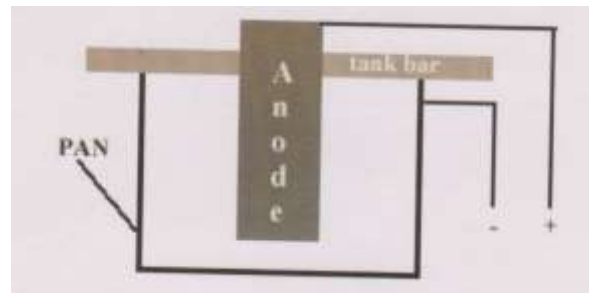
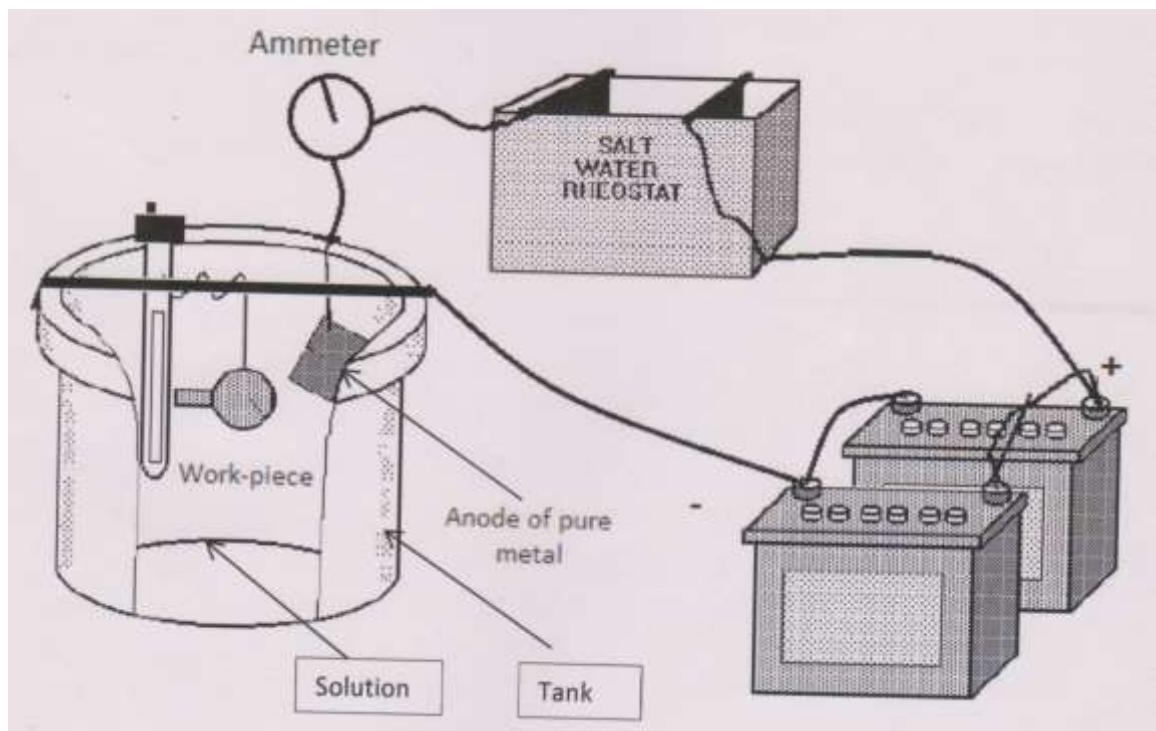

Fig. Arrangement for plating inside parts of a pot



**EXERCISE 13.****10 HRS**

**OBJECTIVE:** The aim of this exercise is to give the concept behind nickel plating and to discuss the procedure of nickel plating.

**MATERIALS REQUIRED:** A dynamo of 5 volts and 80 amperes, resistance board and Vat, 4ft by 2 ft. by 1.5 ft. Chemicals for making 50 gallon of copper solution. Four copper anodes and hooks. Three rods and connections. A hydrometer. Five pounds of cyanide of potassium.

**PROCEDURE:**

**Making Solution:** In a porcelain capsule dissolve 1 oz. of platinum scrap in a hot mixture of 1 part nitric acid and 2 parts of hydrochloric acid. Continue with a gentle heat until all excess acids has been evaporated, and the solution assumes the consistency of thick blood red syrup, then allow this to cool and solidify. Next dissolve this deep red salt (platinum tetrachloride) in hot distilled water, allow the solution to cool and filter through blotting paper. Add a strong solution of potassium cyanide to this until it acquires a clear amber tint, then make up to 1 gal. with distilled water. Make up the bath in a vessel of enamelled iron; commence working at a temperature of 112<sup>o</sup> F.

Nickel plating solution is made by dissolving grain nickel in acid. As these homemade salts may be inferior to those obtainable from good dealers from market.

Quality of a nickel deposit largely depends on the purity of the salts used in making the solution. The salt of nickel in general use for making nickel plating solutions is the double sulphate of nickel and ammonia. This is a beautiful clear sea green salt when pure, and takes the form of crystals, ranging in size from that of peas to that of chestnuts. The salt is merely dissolved in boiling water in the proportion of 1 lb. to each gallon, and poured into the vat when cool. Fairly good solutions may be made with 12 oz. of nickel salt to gallon; but weak solutions offer a high resistance to the current, and the deposit is liable to be powdery and loose. Rainwater is preferable to spring water in making the solution, and it is advisable to pass it through a calico filter into the vat to remove any loose dirt accidentally acquired by the nickel salt.

**PLATING PROCEDURE:** Fill the nickel solution in the tank and maintain the solution at required temperature. Connect the work piece to the negative terminal of the power supply and positive terminal to that of pure nickel. Pass the current of 1-5 amps magnitude for desired duration.

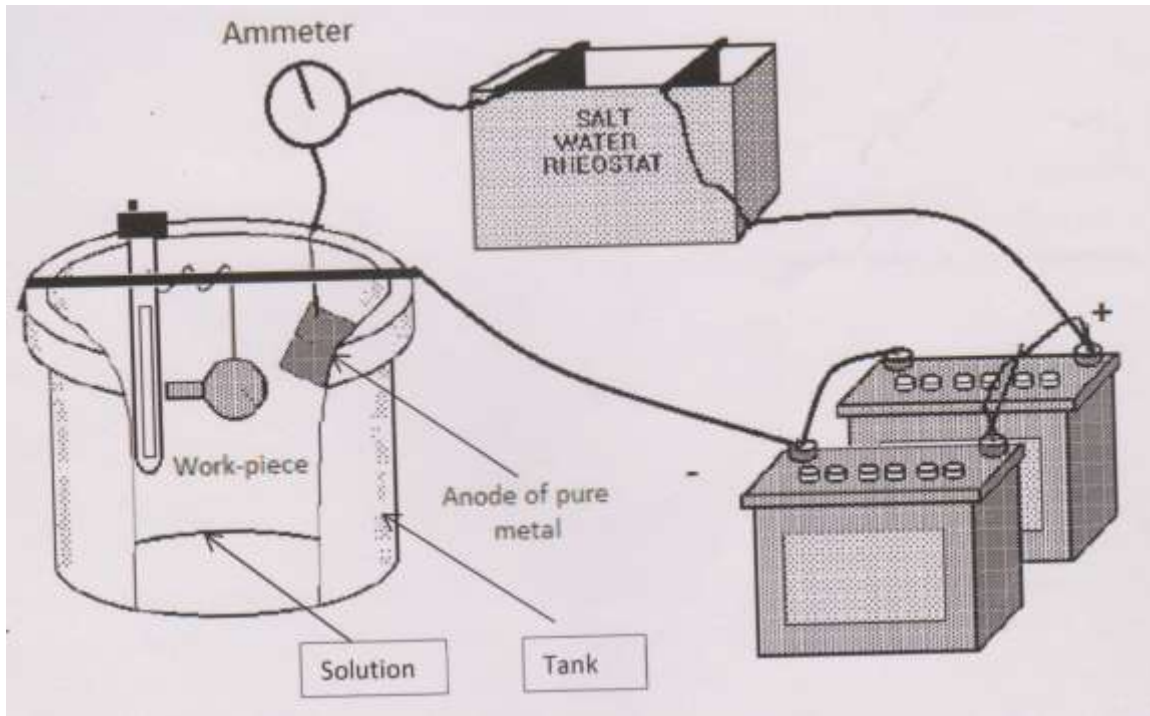

**EXERCISE 14.****10 HRS**

**OBJECTIVE:** The objective of this exercise is to give a basic concept and procedure of gold electroplating.

**THEORY:** Gold is a metal which is mainly used for making ornaments due to its pleasant golden (yellow) colour. Gold may easily be deposited in good condition on a large variety of metals and alloys from a solution of the double cyanide of gold and potassium.

**PROCEDURE:** The first step towards gold plating is making the surface able for gold plating. First of it is cleaning work. A chemically clean surface is absolutely necessary to insure good results in plating. Articles of iron or steel should first be copper plated before going for gold plating.

**Making Solution:** gold solution is usually sent in a concentrated form 24 Karat gold solution may be made as follows:

<b><i>Distilled water</i></b>	<b><i>1 gallon</i></b>
<b><i>Phosphate soda crystals</i></b>	<b><i>9.5 ounces</i></b>
<b><i>Bisulphite soda</i></b>	<b><i>1.5 ounces</i></b>
<b><i>Cyanide potash, C.P</i></b>	<b><i>0.5 ounce</i></b>
<b><i>Chloride gold</i></b>	<b><i>120 grains</i></b>

Heat a portion of the water and dissolve the phosphate of soda in this. Then allow it to cool. In another portion of the water dissolve the bisulphite of soda and cyanide of potash. Dissolve the chloride of gold in the remaining water. Stir this solution slowly into the phosphate of soda solution, after which add the solution of cyanide of potash and bi-sulphite of soda. The plating solution is now ready for use.

**Plating Procedure:** put the solution in the tank used for plating at sufficient temperature. Use a current pressure of 3 to 4 volts from a standard battery. Temperature of about 160<sup>0</sup> FAHR. should maintained. The object which is to be plated is to be connected at cathode and a pure 24 karat gold should be used as anode.

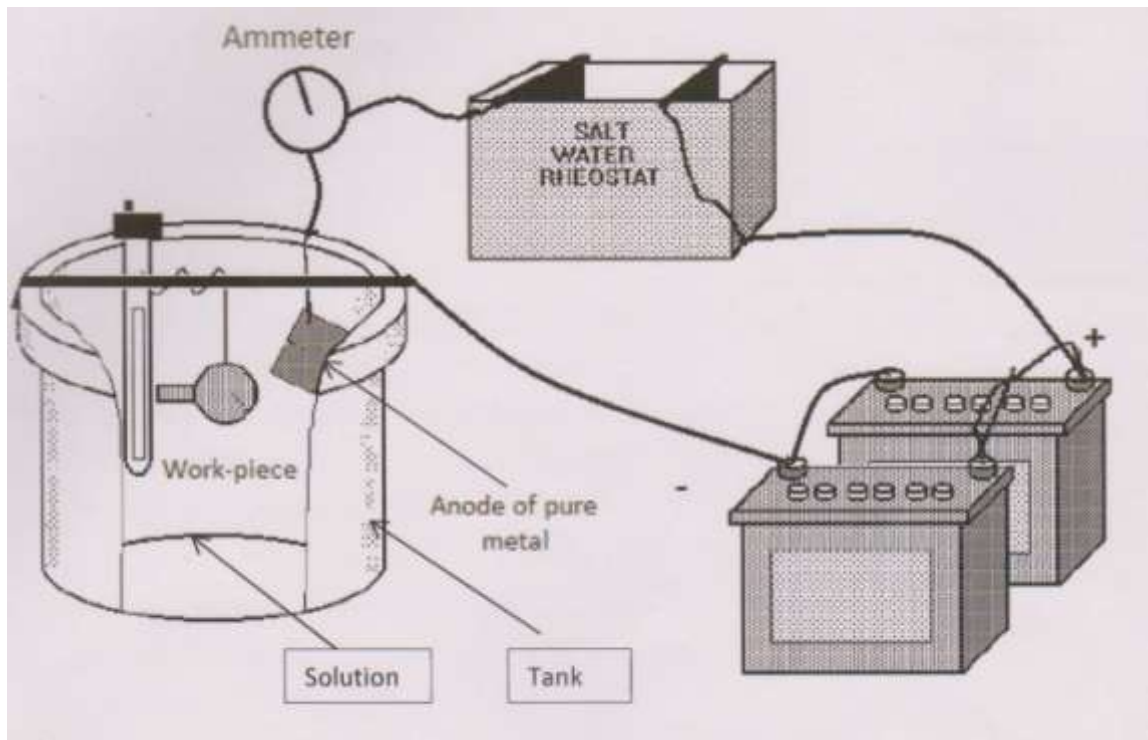

**EXERCISE 15.****10 HRS**

**OBJECTIVE:** the aim of this exercise is to understand the concept and procedure of silver plating.

**PROCEDURE:-**

**Preparation of Silver solution:** The best solution for silver plating is double cyanide of silver and potassium in distilled water. This salt may be made direct from pure silver plates or grains by first dissolving the metal in pure nitric acid diluted with distilled water, then evaporating all excess acid until silver nitrate crystals are obtained then dissolve these in distilled water, and add a solution of potassium cyanide to form a curdy precipitate of the single cyanide, and finally dissolve this with a strong solution of potassium cyanide to form the double salt of silver and potassium. But as the reduction of silver to its nitrate is tedious and noisome, pure silver nitrate is usually obtained from a druggist or dry Salter. It is dissolved in distilled water and then converted into the double cyanide of silver and potassium as above indicated. In doing this, to prevent waste of silver, care must be taken to avoid adding the cyanide solution in a large quantity at a time. The precipitate must also be well stirred with a clean smooth stick of wood after each addition of cyanide, and only enough of this added to throw down all the silver. When precipitation is complete, which is shown by all cloudiness disappearing from the liquid above the precipitate, the liquid must be carefully poured off and taken to the waste tub, and the precipitate of silver cyanide well washed by pouring clean water on it several times, so as to agitate it well; then drain it as dry as possible. To this wet mass of silver curds add a strong solution of the best potassium cyanide in distilled water, until all the curds have been dissolved. The quantity of cyanide in the solution should have been ascertained by weighing the dry salt previous to its dissolution; then add one fifth in excess to provide enough free cyanide of potassium to dissolve the silver anodes in working and thus maintain the strength of the plating solution. The whole concentrated silver solution must next be filtered through well washed calico, and added to the distilled water previously placed in the vat intended to contain the silver plating solution; it will then be ready for use.

Care: gold plating solution is used hot, and will dissolve remaining traces of animal matter, but the silver solution is used cold, and has no such cleansing or detergent effect on dirt left on the surfaces of goods intended to be silver plated. It is necessary therefore to free the surface from the least trace of dirt of any kind, whether in the form of rust, verdigris, tarnish or any other kind of corrosion, or in the form of oil, grease, lacquer, sweat or other animal matter. The touch of a soiled finger on the prepared surface is sufficient to cause the silver to strip off from the spot when the scratch brush or the burnished is applied. All deep scratches, dents, cracks and pits must be removed before goods are plated. All necessary repairs must be done avoiding an excess of soft solder and in the case



of re-plating. All the previous coats of silver or of nickel must be removed, and the surface polished.

**PLATING PROCEDURE:** Use anode plates of pure silver and work cold in a stone ware or glass vessel with current from two or three Daniel cells. The voltage necessary to work this solution is from four to five volts. The current in amperes is in proportion to the surface of goods immersed in the solution at any one time so may range from 1 to 100 amperes. The safe rate is found by experience and various with the character of the work in hand. The plating solution should be kept in good working order. Only distilled water should be allowed in it, and it should always be kept up to a certain mark and thus maintained at the same strength. No chemicals of any kind except potassium cyanide should be added to the solution and this must be used cautiously. A certain quantity of free cyanide must always be present in the plating solution to dissolve the silver anodes at a rate equal to that of the silver deposited. Then the anodes are not coated with black slime, providing all other necessary conditions are fulfilled. But a slimy condition of anodes may be due to an insufficiency of silver in the solution or to an accumulation of dirt. Too much free cyanide in the solution will be shown by a coarse crystalline condition of the anode surface and rapid erosion of the edges of the anodes plates, which soon become ragged. In this solution the deposit is liable to become loose on copper, brass and other metals readily dissolved in cyanide solutions. In making silver solutions, only the best potassium cyanide should be used. This is sold under the name of best grey potassium, 99% cyanide. Inferior cyanide may be employed for pickling solutions but because it contains a large percentage of uncombined potash salts, it should not be used in plating solutions as these too soon become charged with an excess of potash salts, caused by a gradual withdrawal of cyanogens from the free potassium cyanide in solution. In process of time this excess of potash renders the old plating solution unfits for use, as shown by its muddy appearance, and by the rough character of the silver deposited from it. If the muddiness of the plating solution is caused by dirt, filter the whole solution through good calico. This dirt may consist of dust from the workshop, carbon from the potassium cyanide, and finally divided silver from anodes. It should therefore be saved and put in with the waste rinsing water to recover the silver. All water suspected to contain silver should be saved and evaporated in an enamelled iron vessel. The resulting salt being mixed with waste sawdust and sold to a refiner. If a silver plating bath is exposed to strong sunlight, a small portion of the free cyanide will absorb carbonic dioxide from the air and part with its cyanogens, and thus become converted into potassium

carbonate. The loss of free cyanide may easily be made up by adding a small portion of potassium cyanide dissolve in distilled water. When silver plating baths are not in use, they should be closely covered to prevent this loss, and to keep out from dust. They should also be well stirred an hour or two before being used again. As the silver salt will creep up the sides of the vat, and thus find their way to the floor. It is necessary to wash them back into the vat with a little distilled water applied with a stout brush almost every day. An abundance of clean water must be provided for rinsing, and the rinsing waters must be frequently changed. Failure in securing an adherent deposit of silver may often be traced to the use of dirty rinsing waters. The anodes plates, which serve the double purpose of conveying the current into the solution and also keeping up its strength must be pure annealed silver, and their surfaces should always slightly exceed the surfaces of all the articles immersed at any one time. If they fall short of this for any length of time the solution will become impoverished, and on the other hand if their surface is excessive, the solution may get too rich. They should be easily removable.

**EXERCISE 16.****5 HRS**

**OBJECTIVE:** The aim of this exercise is to understand the concepts and produce of burnishing.

**THEORY:** Burnishing is a branch of the electro plating industry in a class by itself and the beginner must not expect to obtain very good results, as to do this requires long and careful practice. Burnishing is done to lay down the frosty or porous deposits of silver or gold. While at the same time it improves the finish and makes a harder and tougher surface. Burnishing is often done on articles having fancy relief patterns or raised borders in order to show a marked contrast to the body of the work.

**PROCEDURE:** To do this work properly the articles must be held so that it will be at all times under the control of the operator without any unnecessary exertion. Attach to the workbench a small projection shelf about 6 inches long by 6 inches wide and about the height of a low desk.

Hold the tool firm with the right hand close to the blade, the end of the handle resting on the operator's left breast. The rounded edges of the tool are the parts to use. Use the narrow edge for first cutting or laying down the metal and the thicker edge for the final polishing.

Slide the tool back and forth over the work with a swift motion, keeping the tool on the work. Care must be taken that the tool does not cut or scrape the work. The tool should be frequently dipped in a jar of soap water. Take a piece of walrus or heavy leather on the bench near the operator for the purpose of keeping the tool highly polished. Cut two small grooves in the leather, in one sprinkle some fine flour emery, in the other sprinkle some fine quality powdered crocus. Rub the edges of the tool frequently first in the emery and then in the crocus. The tool will soon form deep grooves for itself which will aid in the polishing. Burnishers are made in many different shapes to suit the various styles of work.

**EXERCISE 17.****10 HRS**

**OBJECTIVE:** The aim of this exercise is to understand the concepts and procedure of platinum plating.

**PROCEDURE:** If good platinum is obtained from this moderately warm solution with a feeble current, continue to work it, but if the deposit is not satisfactory, raise the temperature and increase the current by using. Platinum solutions demands attention and careful adjustment of temperature and current. As a rule they work best when they contain 1 oz. of platinum in each gallon of liquid, but as the platinum anodes do not dissolve to feed the solutions and thus make up for metal withdrawn from them in deposition, they are continually altering in strength and density. To counteract the effects of this alteration, it is necessary to increase the current and raise the temperature of the solution, or to add enough concentrated solution of the double salt of platinum and cyanide to keep the bath up to its original strength.

To make a solution for depositing lead, dissolve 1 lb. of acetate of lead in 1 gallon of water, and add cyanide of potassium to precipitate the lead as lead cyanide, and then enough cyanide to re-dissolve this, and also to form free cyanide. Work with a pure lead anode and two Bunsens. A brassing solution for use cold is made with 4 oz. each of carbonate of copper and carbonate of zinc recently prepared, 8 oz. each of carbonate of soda in crystals, bisulphate of soda, and pure cyanide of potassium ; -^^ oz. of white arsenic and about 2 gallon of water. Dissolve in water the copper carbonate and zinc carbonate and then add the soda carbonate and soda bisulphate. Dissolve in warm water the cyanide of potassium and the white arsenic, and pour this liquid into the other which becomes rapidly decolorized. Add distilled water to make 2 gal. or slightly more. The following is another method of making an electro brassing solution. Procure 4 fluid oz of nitric acid and dilute it with 2 fluid oz. of distilled water, heat the mixture in a glass or porcelain vessel under the influence of a good draught, and add cuttings of sheet brass until the acid ceases to dissolve. Dilute this with four times its bulk of rainwater, and add liquid ammonia, stirring until the green precipitate first formed has been all dissolved and a clear blue liquid only remains.

To add a strong solution of potassium cyanide until the liquid changes in colour from blue to pink, and then add more cyanide cautiously, stirring until it assumes an amber tint. Allow it to stand like this for twenty four hours, and then filter the clear liquid through calico into the vat in which it is to be used. Work with a good sheet brass anode. Electro brassing solutions are known in great variety, the two just given being among the best of twenty or more. The electro deposition of bronze itself is rarely practised, since most brassing solutions can be made to yield a deposit resembling real bronze in tint, by merely increasing the quantity of copper in the deposit. Electro bronzing can also be done with an alkaline coppering solution made as follows: Dissolve 2 oz. of copper sulphate in 1 qt. Of hot water, add this to  $\frac{1}{2}$  gal. of rainwater containing 4 oz. of potassium carbonate, then add 2 oz. of liquid ammonia and stir until the green precipitate has been dissolved. Mix this liquid with a solution of 6 oz. of potassium cyanide in  $\frac{1}{2}$  gal. of rainwater and filter for use. This solution does best work at a temperature of  $100^{\circ}$  F, but can be worked in cold also with current at a pressure of from 6 to 9 volt. It deposits a bronze coloured copper at low temperatures with the higher voltages. The bronze tint may be deepened by rinsing the coppered good in a solution of salammoniac. (Many of the blocks in this book illustrating electro planters appliances have been kindly lent by Messrs. W Canning and Co., great Hampton street, Birmingham and Messrs. S. J. E. Hartley and son, St. Paul's Square, Birmingham).

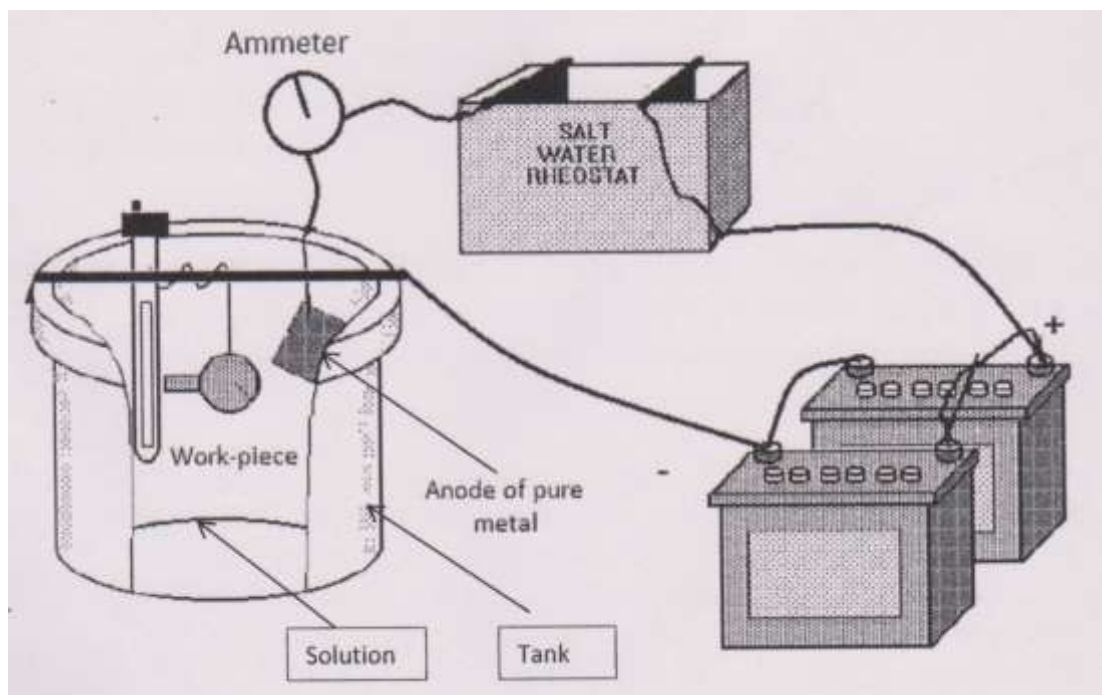

**EXERCISE 18.****10 HRS**

**OBJECTIVE:** The aim of this exercise is to understand the concepts and procedures of chromium electro plating.

**THEORY:** Chrome will resist mostly all organic and inorganic compounds and acids, except hydrochloric acid (muriatic). Chrome is also much harder than casehardened steel. When used as a bearing surface, chrome must be micro finished (more on this later) and will then provide a coefficient of friction lower than any other metal when used against steel, iron, brass, bronze or aluminium alloys. Do not use chrome against chrome. The purity of chromic acid used is often not specified or established and yet the nature.

**REQUIREMENT:**

1. Chromic acid ( $\text{CrO}_3$ ) solution (Do not acquire the hydrogenated ( $\text{H}_3\text{CrO}_4$ ) chromic acid crystals).
2. Temperature control of the bath (plating solution)
3. Lead anodes (peroxide) agitation method of the bath (bubbles)
4. Plating current density controller and duration controller.
5. Properly cleaned work piece.

**PREPARATION OF SOLUTION:** Mix chromic acid and sulphuric acid in proportions of 100:1, take 33 oz. (936 grams) of chromic acid crystals, sulphuric acid fluid 0.33 oz. (9.36 millilitre) and distilled or demineralised water to make 1 gallon (3.79 litre).

**PLATING PROCEDURE:** Fix parameters for temperature, plating solutions, anodes, set up, and current density and plate as usual. Temperature is most important factor for chromed-plating. This is best maintained automatically by using a thermostatically controlled electric heater right in the bath. Typically temperature should be maintained at  $45^\circ\text{C}$ . to  $50^\circ\text{C}$  ( $113^\circ\text{F}$  to  $122^\circ\text{F}$ ). Never change more than one parameter at a time.

Black chrome can also be plated in the same way and still have similar characteristics to the bright chrome. For aesthetic or anti-reflective applications, it may be preferable in some cases. Make solution for black chrome as follows:

**Chromic acid 33 oz (936g)**

**Acetic acid = 28.8 oz (800g)**

**Barium acetate = 1.0 oz (28g)**

**Distilled (or demineralised) water to make 1 gal. (3.79 litre).**

Operation of this bath will be at 90° to 115° F (32.2° C. To 46.1° C.) surgical rubber gloves should be used when handling any of the chemical.

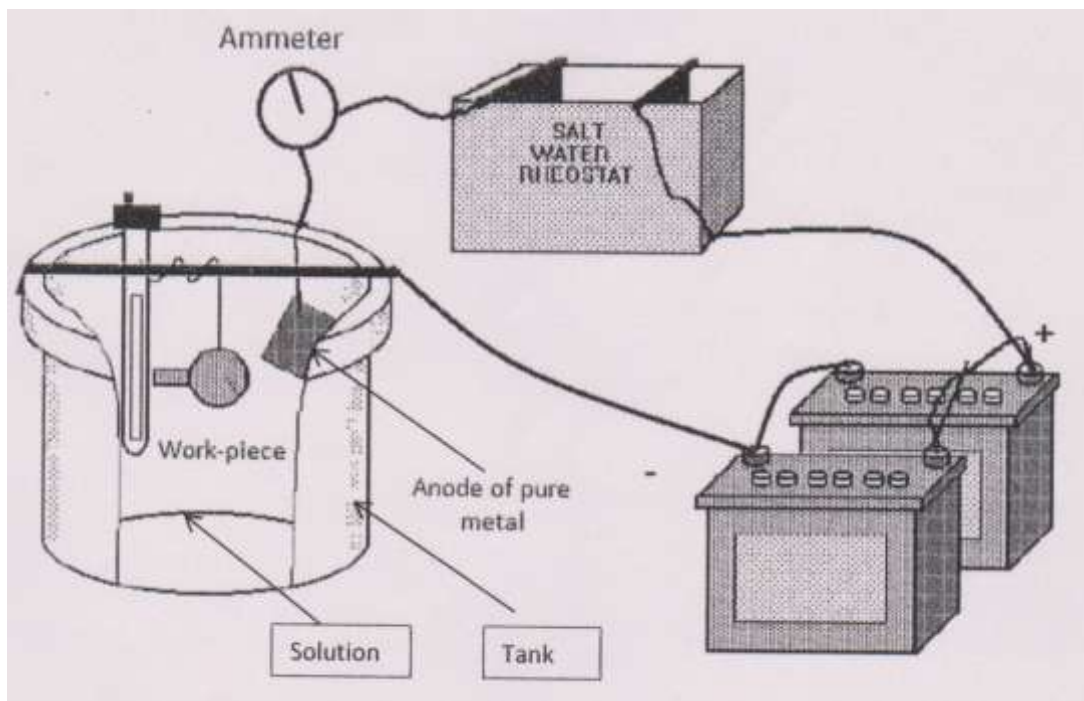

**EXERCISE 19.****10 HRS**

**OBJECTIVE:** Study the concepts and procedure of plating glass tableware, gold and silver plating of glass.

**THEORY:** A typical example of plating on glass is the gilding or silvering of drinking glasses. Gold and silver plating of glass imparts a good appearance and mechanical strength as well.

**MEHODOLOGY:**

1. First of all an enamel of lead borate is prepared as follows.
2. Dissolve a small quantity of lead acetate into a quantity of hot distilled water.
3. Dissolve an equal amount of sodium tetra borate in to a quantity of hot distilled water.
4. Mix the two solutions together. As they are mixed, a white precipitate will form immediately. Filter this through a coffee filter to remove the water and then dry the white precipitate. Heat this in a small crucible, until it melts, then pour it into cold water to granulate it.
5. Dry the granules and then pulverize them. This is lead borate.
6. Depending on which metal you wish to plate, either add 2 parts of silver or gold dust to one part of the lead borate (copper dust could be used, but please bear in mind that the copper colour could be seen in the underside of the glass).
7. Add a small quantity of oil of lavender, enough to make the mix thick enough to handle nicely on a fine paint brush. Applying the coating apply a heavy coat of the enamel, and allow to dry for a day. Small designs and the rims of drinking glasses can be fired over the flame of a hand torch if done carefully. The part must be brought to a dull heat, at which point the enamel fuses. Allow the object to cool very slowly to avoid cracking. Continue to plate with whichever metal you require. Brush plating techniques will work well here.

**SILVERING GLASS:** To silver glass, you need to make up two solutions.



1. Bring one pint of distilled water to a boil and add 25 grains each of **silver nitrate** and **potassium sodium tartrate**.
2. Allow to boil for 5 minutes, then cool and add enough distilled water to make up for the evaporation loss.
3. Dissolve 32 grains of **silver nitrate** in 4 oz. of distilled water. Add **Ammonia**, drop by drop, stirring slowly, the solution will become cloudy, then clear.
4. Add 32 grains of **silver nitrate** and 12 oz. of distilled water, and then filter through a coffee filter. All this work must be carried out using **distilled water** and in glassware. Store the solution in dark bottles, where it will keep indefinitely. To make the silvering solution, mix equal parts of these two solutions together. The glass must be scrupulously clean. A good cleaning technique is to clean the surface with soft scrub, which is a kitchen work surface cleaner with fine abrasive in it. Swab with nitric acid, rinse with fresh water, and then rinse with distilled water. Pour the silvering solution over the wettened surface.

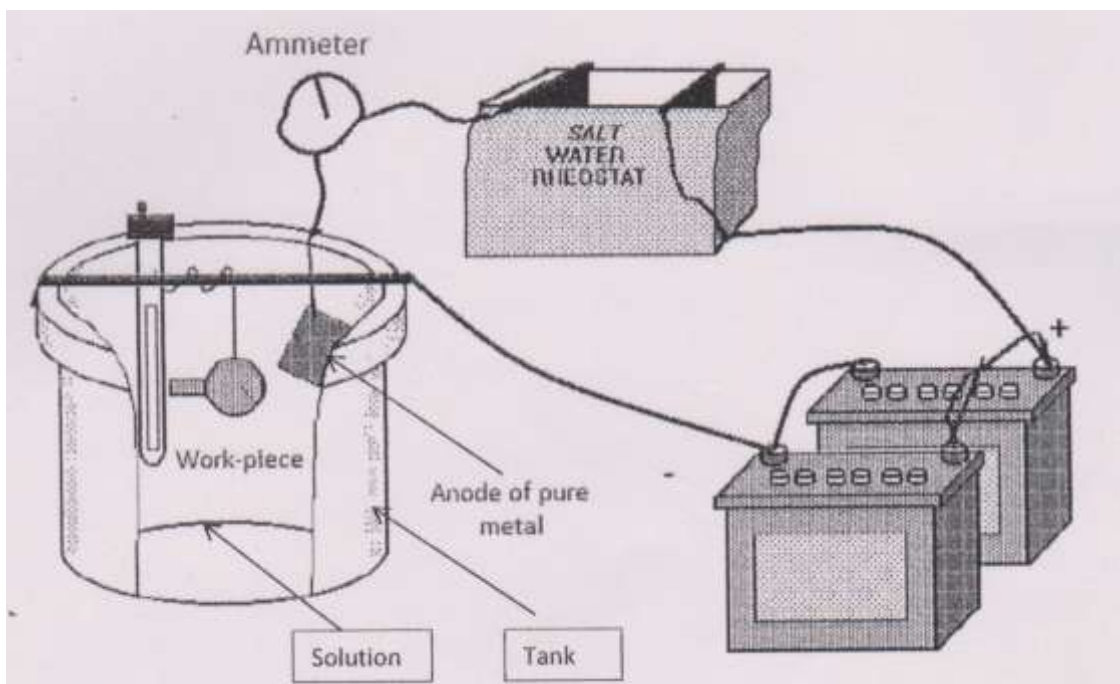

**EXERCISE 20.****10 HRS**

**OBJECTIVE:** The aim of this objective is to study the concepts and procedures of plastic plating. One of the methods is silver nitrate technique.

**THEORY:** This technique is useful for items such as leaves; insects, cloth intricate mouldings, as well as larger items may be treated this way. The part must be capable of being wetted evenly as this is an immersion process. Some items may need to be dried out first, such as plants. Place them in a jar with silica gel, or potassium carbonate for several days. (caswell product may be used).

**PROCEDURE:** Make a solution by using following items:-

¼ oz. Silver Nitrate – available at photography supply stores.

5 oz. rubbing Alcohol – available at drug store

5 fl oz. distilled water

Brush, spray or dip the part in the solution, and allow it to dry. The silver nitrate now needs to be converted to silver sulphide to make it a conductive surface. Place about 2 fluid oz of Bronzer (caswell's) solution in to glass vessel. Hang the part on a thread into the container. In a well ventilated area, pour 1 fluid oz of battery acid solution into the Bronzer solution. Immediately cover the container. Obnoxious fumes are emitted. The fumes will then convert the coating to a conductive surface. After 5 minutes, remove the item and proceed to plating with copper.

**BABY SHOES:** Replace laces if worn. Wash the shoe and laces separately in detergent and allow to dry. Tie the laces, and allow them to fall naturally. Glue them into position using a hot melt glue gun. Glue the tongue into position. Cut off any frayed stitching etc. to aid in sinking the shoe, you may pour some plaster of paris into the toe. This will also help the shoe keep its shape. Allow to thoroughly dry. Affix plating wires to the shoe. You could put a couple of wood screws in the sole and heel of the shoe and also use the shoelace holes. The more wires the better conductively you will get. Immerse the shoe into the mixed **caswell sealer** for 30 minutes, stirring occasionally to remove any entrapped air bubbles in the toe area. **Caswell sealer** comes in concentrated form. 1 quart of sealer must be

mixed with 2 quarts of **lacquer thinners** before use. Make a shoe rack by hammering several 4" nails in to a small plank of wood. Invert the shoe over the nail and allow it to drain and thoroughly dry for about 4-8 hours. Dip the part into **caswell sealer** momentarily, and allow drying, and then repeating. Mix a 4 oz. bottle of **caswell conductive powder** into a quart of **lacquer thinners**. Thoroughly stir. Contents will settle so make sure you thoroughly stir each time you use this material. Do not add any **sealer** to this mixture. Spray **conductive powder** mix all over the shoe, avoiding runs, to provide an even coverage. The coating should extend into the shoe as far as possible. Allow to dry. Make sure the wires are well coated; otherwise you will not conduct power to the surface of the shoe. To aid the plating procedure, you may dip the object to be plated in **caswell tinning solution**. This coats the entire part with a thin layer of tin, which aids in even plating coverage. The part should be dipped into the solution of approx 30 seconds, and then rinsed in fresh water. This procedure is optional. Use only if you are experienced in facing difficulties in obtaining even coverage of the copper plate. Suspend the shoe from the tank bar, which should already be wired to the power unit., and immerse in the copper plating tank. The shoe should immediately start plating. The average baby shoes will measure approximately 25-30 square inches so should be plated at the rate of (1 amp per 20 sq") 2-3 amps. Plate for approximately 1 hour. Remove and inspect. Sand/emery any rough spots. Continue plating for about 3-5 hours, checking periodically for any rough spots, which should be sanded smooth. Smooth cloths and leather will have different appearances. Rinse the part off, then polish lightly and then proceed to the section in this book, **Antique and Blackening Techniques**, for a choice of antiquating finishes, or plate with nickel and or gold. If plating with nickel, gold or silver, then the part needs to be polished to a high shine, to give best effect. Brush the shoe with steek wool or a soft buffing wheel and compound to remove the antiquing oxides and expose the copper on the high spots. Finally dip into **caswell sealer** and rack to dry.



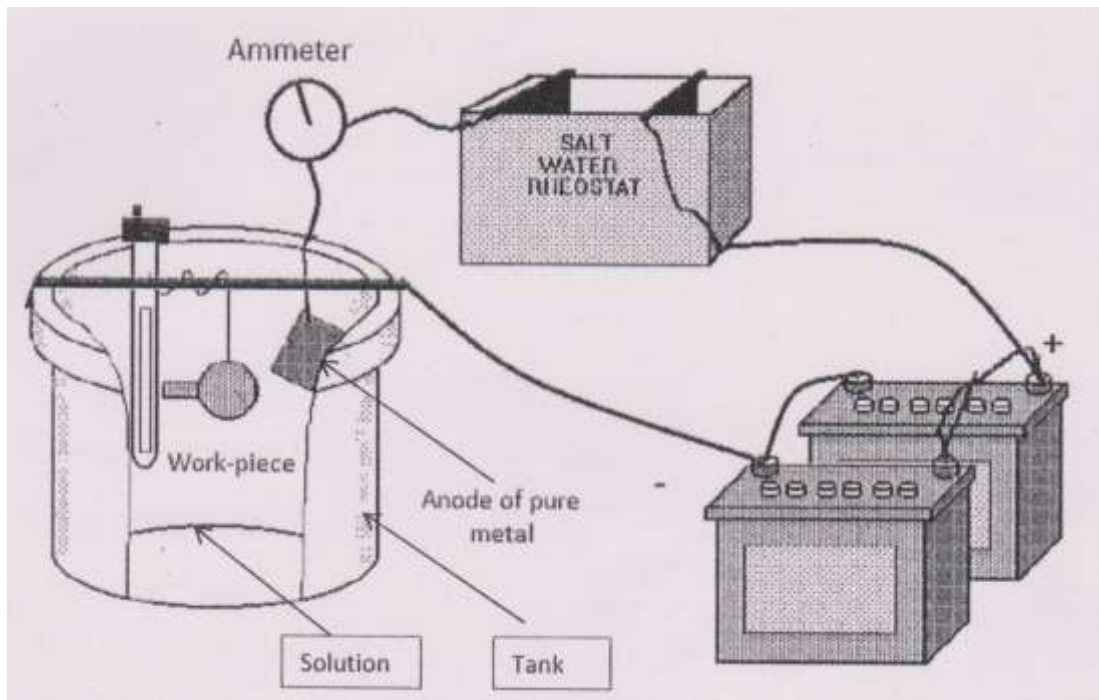

**EXERCISE 21.****3 HRS**

**OBJECTIVE:** The aim of this exercise is to understand the concepts and procedure of preparation of work piece before plating.

**PREPARATION OF WORK BEFORE PLATING**

In all electro plating operations the articles to be plated must be perfectly smooth and free from even the slightest scratches or imperfections, as these will show very plainly after plating. They must then always be dipped and rinsed until all traces of grease or foreign matter are removed, before being placed in the plating solution. The higher the polish of the article the finer the finish will be after plating.

To accomplish this result, the articles must, with few exceptions, be put through a series of operations in the following described order:

**PROCEDURE:****STEPS**

1. Pickle to remove scale, sand and rust.
2. Emery wheel to remove burrs or imperfections.
3. Polishing wheels set up with glue and emery (various grades).
4. Remove scratches left by polishing wheels.
5. Colouring wheel to produce fine finish.
6. Rinse in cold water.
7. Acid dip to remove oxide (for iron and steel)
8. Cyanide dip to remove oxide (for brass, copper, silver and gold)
9. Rinse in cold water to remove acid or cyanide,,,  
Then pass to the plating solution.

**EXERCISE 22.****10 HRS**

**OBJECTIVE:** The aim of this exercise is to understand the difficulty faced in aluminium plating and the procedure of aluminium plating.

**THEORY:** Aluminium forms an oxide the moment it is exposed to the air. This presents a problem when plating it, as the oxide prevents the plate from sticking. By using the Zincate process as a pre plate dip, you chemically remove the oxide layer and at the same time, apply a layer of zinc. The zinc protects the aluminium from further oxidizing until it is ready to be plated. As the part is lowered into the plating tank, the zinc is etched away by the solution and plating proceeds onto a clinically clean surface.

**PROCEDURE:** Clean the work to remove all heavy oxides and contaminants. Buff and polish to the required shine. The part should then be thoroughly degreased in degreaser.

Make up a solution of Zincate by adding 25% by volume of the concentrate to a plating tank (Pyrex, plastic etc.) and fill with distilled water. i.e.:- Add 250ml of Zincate, then top up to 1 litre mark of the tank with distilled water. Heat the solution to 75 degree F. An aquarium heater will do this quite easily. Immerse the part in the solution for 15 second to 2 minutes.

Immersion time will depend on the alloy, Zincate condition and temperature. If the alloy reacts violently with the solution, then shorten the time immersed. If no reaction is visible then immersion times can be extended. A uniform gray appearance is usually a sign of a properly zincated surface, however there are cases where a dark, slightly streaked surface is acceptable. As the Zincate solution is depleted, there will be a noticeable increase in the gassing. You can replenish the solution by adding about 10% of the Zincate concentrate, or simply make up a fresh batch. Rinse the part and prepare for plating (say Nickel Plating) in regular way.

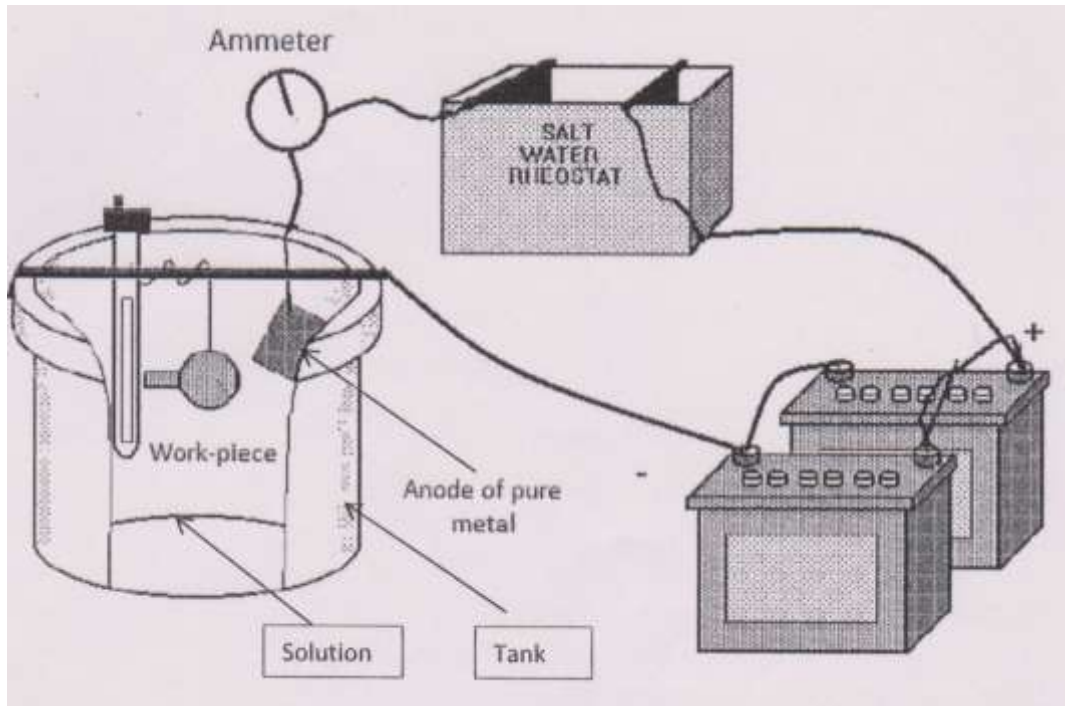

**EXERCISE 23.****10 HRS**

**OJECTIVE:** The aim of this exercise is to understand the concepts and procedure of de plating a electroplated work piece.

**THEORY:** De plating process is also a kind of electroplating process. It works opposite to that of electroplating.

**PROCEDURE:** Connect the work piece to be stripped to anode (positive) and the pure metal to cathode connection of the power unit, and immerse it in the solution that was used for electroplating. Adjust current until a current density of  $\frac{1}{2}$  to a amp. Per. Sq. In. Is obtained. Maintain this current density for desired time interval. Remove work and inspect to see if all metal (say copper) has been removed. If not repeat cycle as outlined previously.

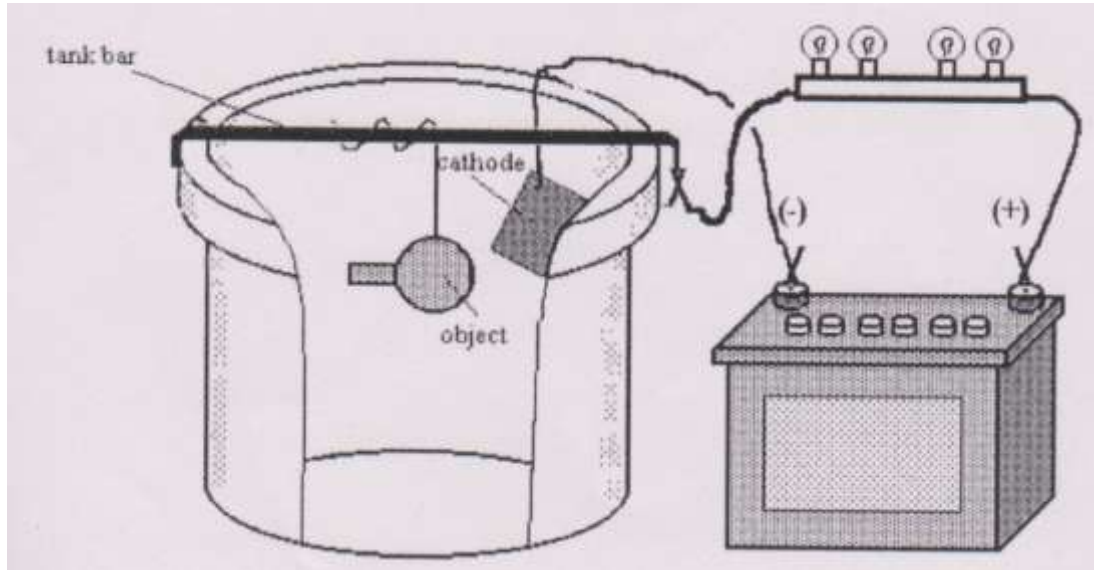



**EXERCISE 24.****3HRS**

**OBJECTIVE:** Understanding the safety procedure in electroplating operation.

**THEORY:** The major problem with any larger plating operation is the emission of fumes from the tanks during the plating process. In the case of nickel, copper, copy cad, copy chrome and zinc plating. The fumes are hardly noticeable, and do not pose any major health risk. However the chrome, SP degreaser and de plating tanks do give off unpleasant and potentially dangerous fumes. These need to be considered and controlled.

Automatic rubber respirators are used when working in fumes, vapours, smoke and all kinds of dust. They will be found a great relief in all dipping operations where are obnoxious acid fumes arise from the dips, also in all dusty, grinding and polishing operations.

They are provided with a closed and protected automatic ventilating valve, which operates under all conditions, thus securing perfect ventilation. A fine, damp sponge or a wet, silk cloth is the best filtering material for separating impurities from the air, and when these two valuable filtering materials are combined in their action, the protection is practically complete and it is a very difficult matter for fumes or gases to pass through the respirator.



**PRECAUTIONS TAKEN IN ELETROPLATING INDUSTRY.**

You should use goggles, gloves and an apron while using your plating operation.

1. Keep a box of sodium Bicarbonate (Baking soda) handy, sprinkle on the spill to neutralize the acid. Then mop and flush.
2. Don't pour water into any acid, it can heat up and sometimes explode. Pour acid into water.
3. Don't come in contact with chrome acid. It will burn, stain and is a dangerous material if not treated with respect.
4. Don't think you can get away without taking safety precautions. You can't!
5. Don't leave the lids off your tanks when not in use. They will get knocked over.

Most plating chemicals contain heavy metals. They should not be flushed down drains, even in small quantities. We suggest you manufacture a small fume hood and or/install a fan system to move the fumes away from yourself. An ideal readymade inexpensive hood is a kitchen stove fume hood. The use of a respirator is also advisable.

# Treatment of Electroplating Wastes

PDF

By H. S. S. CHIU, B.A., M.P.H. (Member), K. L. TSANG, B.Sc., M.Sc., D.I.C. (Member) and  
R. M. L. LEE, B.Sc., B.A.Sc (Member)

Senior Consultant, Consultant and Assistant Consultant, Environmental Management Div., Hong Kong  
Productivity Council, respectively

## INTRODUCTION

With the increasing concern over the protection of the environment, the electroplating industry is likely to be one of the industries to be affected by the introduction of the water pollution control legislation in Hong Kong. The effect may be even more pronounced for the operators of small and medium-sized electroplating factories since they are unlikely to have any expertise in pollution control and will therefore require outside technical information and assistance.

During the past few years, the Hong King Productivity Council has acquired first hand data on the characteristics of effluent discharged from local electroplaters and has been involved in the design of wastewater treatment systems for a number of plating factories.

The purpose of the paper is to present a review of some findings of the Productivity Council on the treatment of electroplating wastes. In the paper, the typical electroplating processes appropriate to local factories as well as the general characteristics and volume of the plating wastewater are discussed. The various practical measures that can reduce pollutant discharge and some methods of treatment of electroplating wastes are also described.

## THE ELECTROPLATING INDUSTRY OF HONG KONG

According to the Census and Statistics Department of the Hong Kong Government there were approximately 847 electroplating establishments in Hong Kong at the end of June 1984 (including buffing and polishing establishments) and about 98% of them were predominantly small and medium-scale operations employing less than 50 employees. These plating factories, like the other local manufacturing industries, are generally housed in multi-storey industrial buildings which are uncommon for other areas outside Hong Kong.

## TYPICAL ELECTROPLATING PROCESSES

The types of plating processes practised in Hong Kong are plating of copper, nickel, chromium, zinc, gold, silver, tin, lead as well as aluminium anodizing. A great majority of the electroplating shops are engaged in the plating of copper, nickel and chromium for decorative metal surface finishing. It is also common that in a single factory several different types of plating are practised at the same time. The typical chemical compositions of the various types of plating baths used in Hong Kong are summarized in Table 1, which shows that the plating baths are generally highly acidic or alkaline and often contain toxic substances such as cyanide and heavy metals. Hence, their discharge and disposal should be carefully controlled and treated to minimize the impact on the receiving water-bodies.

TABLE 1. TYPICAL CHEMICAL COMPOSITIONS OF THE PLATING BATHS USED IN HONG KONG

Type of plating	Plating bath composition	
Copper	Copper cyanide	20-25 g/l
	Sodium cyanide	30-35 g/l
	Sodium carbonate	15-30 g/l
Nickel	Nickel sulphate	240-300 g/l
	Nickel chloride	45-60 g/l
	Boric acid	30-40 g/l
Chromium	Chromic acid anhydride	250-400 g/l
	Sulphuric acid	2.5-4.0 g/l
Zinc	Zinc metal	25-45 g/l
	Sodium cyanide	35-105 g/l
	Sodium hydroxide	35-115 g/l
Tin	Stannous sulphate	30-50 g/l
	Sulphuric acid	40-70 g/l
	Phenolsulphuric acid	30-60 g/l
Tin-Lead	Stannous sulphate	12-20 g/l
	Lead	8-14 g/l
	Fluoboric acid	350-500 g/l
Gold	Potassium gold cyanide	1-6 g/l
	Potassium cyanide	30 g/l
Silver	Silver cyanide	36-75 g/l
	Potassium cyanide	60-90 g/l
Aluminium anodizing	Sulphuric acid	15-25% (wt)

TABLE 2. CHARACTERISTICS OF PLATING WASTEWATER DISCHARGE FROM SIXTEEN LOCAL ELECTROPLATING SHOPS

Plating operation	Factory area (m <sup>2</sup> )	Parameter							
		pH	Chromium (Cr) (mg/l)	Cyanide (CN) (mg/l)	Copper (Cu) (mg/l)	Nickel (Ni) (mg/l)	Zinc (Zn) (mg/l)	Aluminium (Al) (mg/l)	Silver (Ag) (mg/l)
Ni and brass	20	8.0	—	6	2	150	4	—	—
Ni and Zn	25	7.7	1	—	—	106	4	—	—
Cu, Ni and Zn	60	4.0	33	6	4	168	250	—	—
Cu, Ni and Cr	70	5.2	20	4	2	30	—	—	—
Cu, Ni and Au	80	7.8	1	2	1	5	—	—	—
Aluminium anodizing	100	6.2	3	—	—	—	—	10	—
Aluminium anodizing	100	2.7	—	—	—	—	—	230	—
Cr, Ni and Cr	120	2.5	31	4	2	13	—	—	—
Ni and Zn	150	8.2	1	—	—	95	10	—	—
Cu, Ni, Cr and Ag	150	1.7	9	1	—	8	—	—	2
Cu, Ni and Cr	200	4.5	25	6	3	230	—	—	—
Cu, Ni, Cr and brass	200	7.0	40	1	11	365	15	—	—
Cu, Ni, Ag and Cr	250	1.9	3	1	—	11	—	—	3
Ni, Cr and Au	300	5.6	38	—	—	3	—	—	—
Cu, Ni, Cr and brass	400	7.7	5	5	30	25	10	—	—
Cu, Ni and Cr	1000	5.5	20	3	1	15	—	—	—
Range	20-1000	1.7-8.2	1-40	1-6	1-30	3-365	4-250	10-230	2-3

#### CHARACTERISTICS OF WASTEWATER

More than 90% of the wastewater discharged from a plating shop comes from rinsing of workpieces with the occasional discharges of process solution, spillage or cleaning of process devices.

The characteristics of electroplating wastewater are a function of the types of plating processes, rinsing methods and plating practices. Table 2 presents the typical plating wastewater characteristics of sixteen electroplating factories surveyed in Hong Kong. The wastewater samples were collected from the main discharge pipes of the factories and therefore represented the combined characteristics of the various types of wastewater from various processes. According to the information obtained during the survey of the local electroplating factories, it was found that the characteristics of the plating wastewater varied from one factory to another even though both might be engaged in the same plating processes.

As observed during the survey, the combined plating wastewater was generally clear, colourless

and with a pH ranging from acidic to slightly basic (pH 1.7-8.2).

Cyanide was detected in the combined wastewater discharged from copper and zinc plating factories with concentrations ranged from 1-6 mg/l. As the baths of these two plating processes contained cyanide, the sources of cyanide detected in the wastewater should be derived from the washing of the drag-out solution still attached on the surface of the plated items.

Similarly, chromium was detected in substantial amount (1-40 mg/l) in the wastewater discharged from factories engaged in chromium plating and zinc plating. The sources of the chromium were from the drag-out of the chromium plating bath and the passivating bath of the zinc plating operation. The chromium in the wastewater existed mostly in the hexavalent form.

Depending upon the type of plating processes, heavy metals such as copper, nickel, zinc, aluminium and silver were also detected in the wastewater and

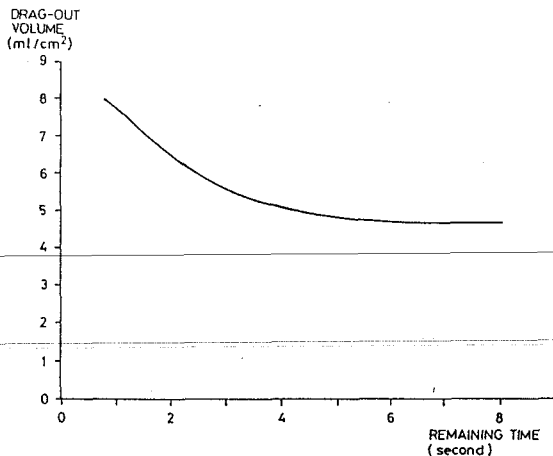

Fig. 1. Variation of drag-out volume with the remaining period of workpieces above a plating bath

the concentrations of which were generally less than 400 mg/l.

In summary, the combined plating wastewater generally contained cyanide, hexavalent chromium and heavy metals. As these chemicals possess a certain degree of toxicity to the human health and aquatic life, it is therefore necessary to provide treatment to reduce the level of these contaminants before the waste-water is allowed to discharge into receiving water-bodies.

#### METHODS TO REDUCE POLLUTION DISCHARGE

In order to minimize the cost of treatment of electroplating wastes, it is necessary for electroplaters to adopt measures to reduce pollutant discharge and volume of effluent. Some examples of these measures are described below.

##### Methods of Reducing Pollutant Discharge

(1) *Use of properly designed racks.* Workpieces to be plated are hung on racks which are generally coated with a thin layer of plastic material for insulation purposes. The total surface area of the racks usually amounts to 10–30% of that of the workpieces. In order to minimize the extra drag-out volume due to the racks, they should be properly designed to improve drainage such as evenly coating the racks with plastic materials and even to the point of placing drainage holes in appropriate places on the racks. However, this design aspect is often overlooked by local electroplaters.

(2) *Speed control of removal of workpieces from plating bath.* The speed of removal of workpieces from a plating bath is an important factor affecting

the volume of drag-out. From Fig. 1, it can be seen that the longer the period that workpieces remain above the plating bath after emerging from the plating bath the lesser the volume of drag-out that will result. If the remaining period above the plating bath is 3 second or more, the drag-out volume reduces to about 60% of that at 1 second. In actual plating processes the remaining period should therefore be controlled at 4–6 seconds.

##### Methods to Minimize Waste Rinse Water

As observed during the factory visits, local electroplating factories often use an excessive volume of water to clean the surfaces of the plated workpieces without due regard to the washing efficiency. This unnecessarily large volume of rinsing water discharged will result in the increase of the capital cost of the treatment system. Hence, in order to reduce the cost of treatment of wastewater, measures have to be adopted to reduce the volume of rinsing water used. Some of the practical measures to reduce the consumption of rinsing water are:

(i) *Addition of air-mixing in rinse tanks.* Air mixing facilities, when added to rinse tanks, can increase the efficiency of rinsing by adequately providing turbulence between the workpieces and the rinse water and thus effectively remove the drag-out solution from crevices of the workpieces. However, it should be noted that the air pressure applied should not be excessive in order to avoid workpieces loosening from the hanging racks. It has been found that in a rinse tank of 460 mm water depth a 0.5 kg/cm<sup>2</sup> air pressure is sufficient to provide good mixing. Air supply can be accomplished by a perforated tube which is typically 20–25 mm diameter.

(ii) *Improving rinsing practices.* Improvement in rinsing practices can result in the reduction of waste rinse water volume and, more importantly, in ensuring the quality of workpieces.

In Hong Kong, some electroplaters still use a single rinse tank system, the disadvantage of such a practice being that it requires a large amount of water

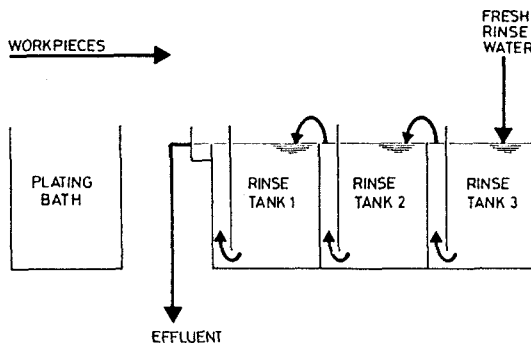

Fig. 2. Use of a countercurrent rinsing tank

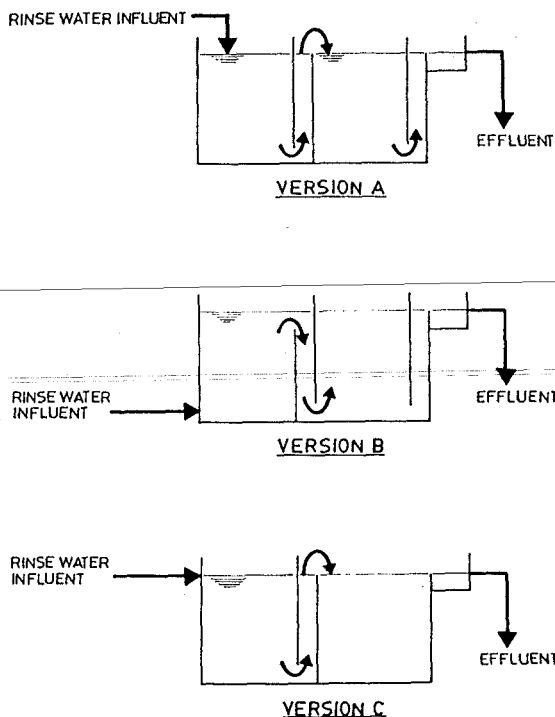

Fig. 3. Design of different types of rinsing tanks

to achieve the desired standard of cleanliness for the workpieces which is unfavourable in terms of wastewater treatment.

A superior rinsing practice is countercurrent rinse (Fig. 2) whereby the amount of rinse water required can be much reduced. In fact, the total rinse water flow needed to achieve the same degree of cleanliness decreased by about 90% for each additional rinse tank in the countercurrent sequence as compared to using only one tank. For example a rinsing system may require 100 l/min. of water for single rinsing, with two rinse tanks connected in series for countercurrent rinsing the flow can be reduced to 10 l/min., and for three rinse tanks only 1 l/min. is required. At such slow water flow rates air mixing should be used to provide adequate turbulence. The disadvantage is that the work requires more processing steps and more equipment and space are mandatory. Hence, in practise the use of countercurrent rinsing is limited to two rinsing stages.

(iii) *Improved rinse tank design.* It has been observed in local electroplating factories that the importance of the design of the rinse tank has often been overlooked. In a poorly designed rinse tank, short-circuiting between influent and effluent rinse water is common, which results in poor rinsing efficiency.

In order to improve rinsing efficiency and thus

achieve a reduction of the volume of rinse water required, the inlet and outlet of the rinse water to and from a rinse tank have to be properly designed. Fig. 3 shows three versions of rinse tank design, the best rinsing efficiency achievable by version A followed by B and lastly C.

In essence, a properly designed rinse tank should be able to prevent short-circuiting and allow rinse water to mix adequately, resulting in uniform concentration in the tank and also provide cleaner fresh water at the tank's surface so that when the workpieces emerge from the tank they are rinsed by the cleaner rinse water.

### TREATMENT OF ELECTROPLATING WASTES

In general, the contaminants contained in the electroplating wastewater that are toxic in nature and require treatment are cyanide, hexavalent chromium and heavy metals.

Several types of treatment methods have been developed for each specific contaminant. Each treatment method has its particular application and constraints. Table 3 summarizes the more common methods of treatment of the three types of contaminants.

#### Treatment of Cyanide

(1) *Chlorination.* The use of sodium hypochlorite to oxidize the cyanide to less toxic products is the most widely practised treatment method and is considered to be most suitable to small electroplaters of Hong Kong.

TABLE 3. METHODS OF TREATMENT OF ELECTROPLATING WASTES

Parameter	Type of treatment method
Treatment of cyanide	Chlorination Ozonation Electrolysis Ion exchange
Treatment of hexavalent chromium	Reduction to trivalent chromium and precipitation Cementation Precipitation as barium salt Ion exchange
Treatment of metals	Neutralization and precipitation as hydroxides (for non-complexed metal) Precipitation as metal sulphide (for both complexed and non-complexed metal) Destruction of complexes and precipitation (for complexed metal) Ion exchange

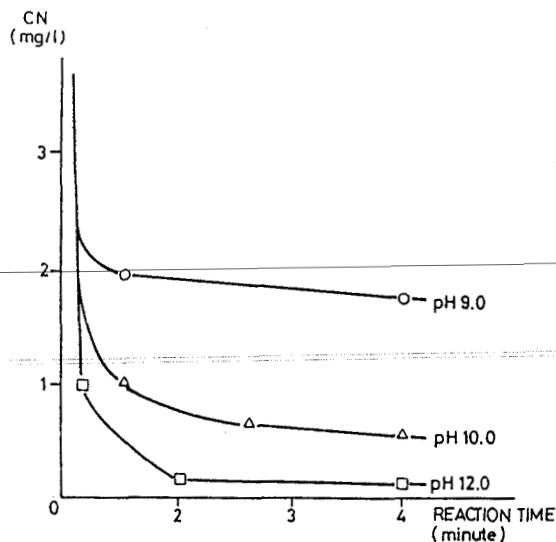
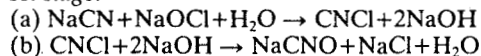

Fig. 4. Effect of pH on the destruction of cyanide by chlorination

The destruction of cyanide by sodium hypochlorite is accomplished in the following stages:

*1st stage:*



*2nd stage:*

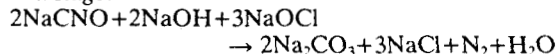

*Overall:*

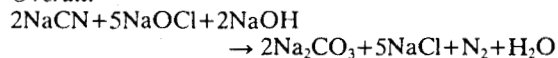

The rate of destruction of cyanide is pH dependent and may be affected by the presence of metals. Figs. 4 and 5 show the effect of pH and different metal concentrations on the rate of reaction.

(2) *Ozonation.* Similar to chlorination, the destruction of cyanide by ozone occurs in two stages, with cyanate formed as an intermediate:

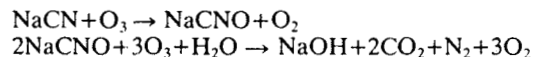

*Overall:*

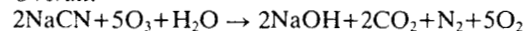

In contrast to chlorination, strict pH control is unnecessary and consumption of chemicals can be reduced when the wastewater contains a substantial amount of ammonia. However, the initial capital costs and operating costs of this method are higher than those of chlorination.

(3) *Electrolytic oxidation.* Oxidation by anodic oxida-

tion is particularly suitable for high concentrations. Removal rate can be as high as 260–380 mgCN/Ah for cyanide concentrations between 1000–3000 mg/l, but rapidly decreases at lower concentrations (Fig. 6). Electrolytic oxidation is mainly used to pre-treat highly concentrated cyanide waste from an electroplating shop, where there is direct current power supply, to a lower concentration after which conventional chlorination oxidation is used for complete treatment. The operating cost for the destruction of cyanide by electrolysis at high concentration is only about 40–60% of the cost of chemical treatment of chlorination.

(4) *Ion exchange.* Cyanide in wastewater may be removed by adsorption on anionic exchange resins. The adsorbed cyanide may later be eluted off by passing regenerants, such as sodium hydroxide or sodium chloride, through the resins. The regenerated cyanide may be reused as process chemicals or treated before discharge.

#### Treatment of Chromium

(1) *Reduction of hexavalent chromium and precipitation.* The most widely used method of treating hexavalent chromium is to reduce it chemically to a trivalent state and subsequently precipitate it out of solution as hydroxides. The common chemical reductants used by small electroplaters are sodium sulphite ( $\text{Na}_2\text{SO}_3$ ), sodium bisulphite ( $\text{NaHSO}_3$ ), sodium metabisulphite ( $\text{Na}_2\text{S}_2\text{O}_5$ ) and ferrous sulphate ( $\text{FeSO}_4 \cdot 7\text{H}_2\text{O}$ ).

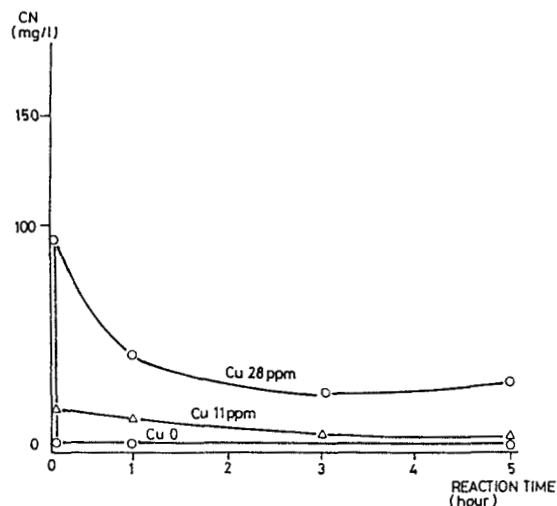

Fig. 5. Effect of metal concentration on the rate of destruction of cyanide by chlorination

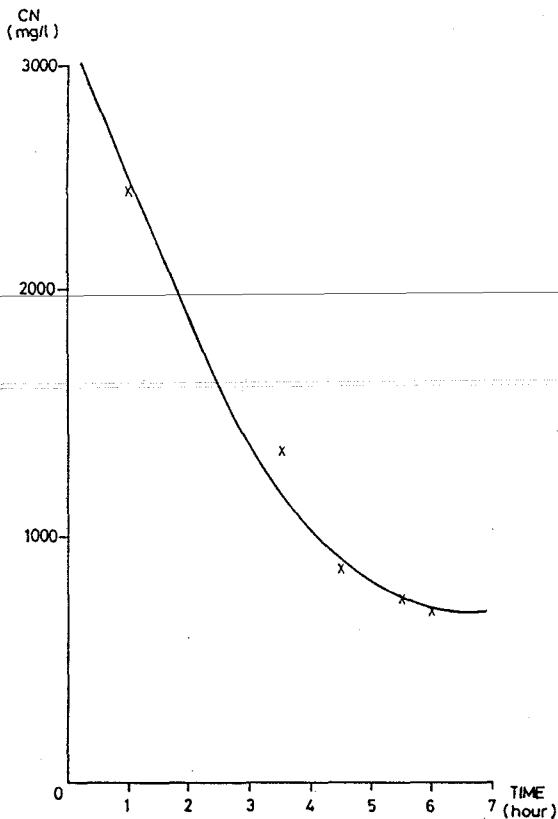
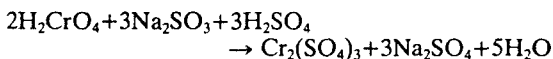

Fig. 6. Destruction of cyanide by electrolysis

The reduction reactions are:

With sodium sulphite:



With sodium bisulphite:

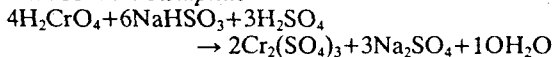

With sodium metabisulphite:

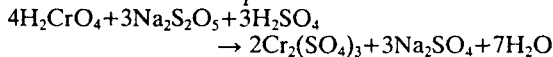

With ferrous sulphate:

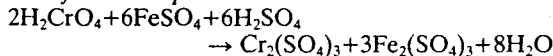

All the above reactions have to take place at pH 2.5–3. The effect of pH on reaction rate of reduction of hexavalent chromium by sodium metabisulphite is illustrated in Fig. 7. The trivalent state chromium can then be precipitated as chromium hydroxides by pH adjustment.

(2) *Cementation*. Cementation is the use of scrap metal to electrochemically reduce the hexavalent chromium. By allowing the electroplating waste con-

taining hexavalent chromium to come into contact with scraps of reactive metals (such as iron, zinc or aluminium), the hexavalent chromium is reduced. Although the cementation reactions with zinc and iron have to be carried out under acidic condition, the cementation reaction with aluminium scraps under alkaline condition has been tried with some degree of success. In this way, the reduction of hexavalent chromium to trivalent state and the precipitation of trivalent chromium can be accomplished in one step. Thus, this treatment process requires less operator attention and reduces the need for sophisticated control equipment. Fig. 8 shows some of the experimental results of alkaline cementation reaction with aluminium scraps.

In summary, the use of metal scraps for chromium treatment can lower the chemical costs and simplify the treatment operation by eliminating the need for careful dosage of treatment chemicals.

(3) *Precipitation as insoluble barium salt*. It is possible to precipitate chromium in the hexavalent state by forming the insoluble barium chromate.

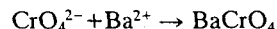

The reaction can be carried out at pH 8–9 and is only used as an emergency remedy because barium salt is expensive. Lack of treatment is apparent by the presence of a yellow colour which indicates the presence of unreduced chromate ions.

(4) *Ion exchange*. Ion exchange is one of the more widely employed chromium and chromic acid recovery processes. Although cation exchange may be used to recover trivalent chromium it is seldom practised due to complexity of operation. On the other

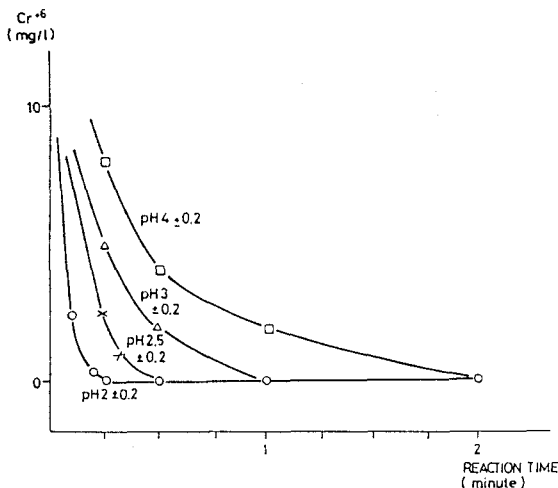

Fig. 7. Effect of pH on reduction of hexavalent chromium by sodium meta-bisulphite



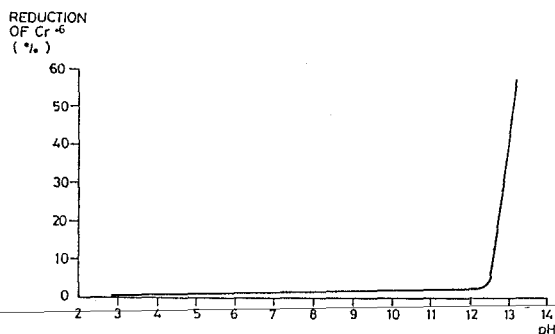

Fig. 8. Reduction of hexavalent chromium with aluminium at various pH values

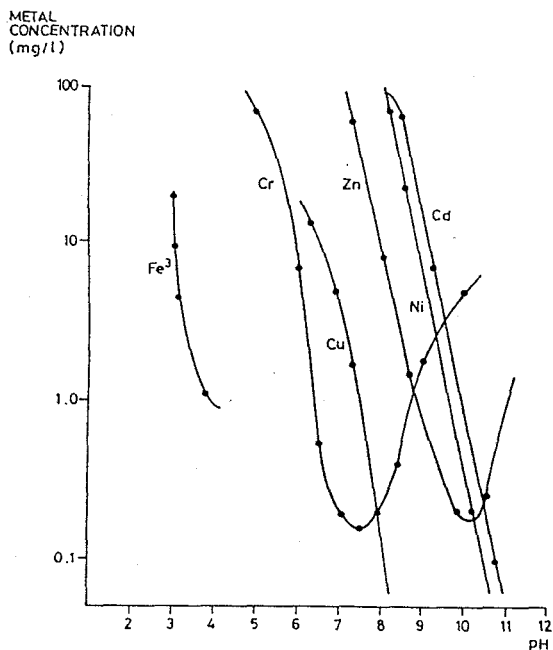

Fig. 9. Precipitation of metal salts at various pH values

hand, anion exchange is used for hexavalent chromium. With anion exchange, concentrated regenerated solution of up to 6% chromium acid may be obtained for re-use.

#### Treatment of Metal

(1) *Removal as hydroxides.* Precipitation of metals contained in the electroplating waste is the most widely adopted treatment method for removal of metals. Each metal species has a particular optimum pH range for its maximum removal. Fig. 9 shows the recommended pH range for the removal of some common metals as metal hydroxides<sup>1-3</sup>.

The more commonly used chemicals for pH adjustment are caustic soda and lime, caustic soda being the more expensive. However, it will contribute to a much smaller amount of sludge generated

when compared to the use of lime. Lime is cheaper to purchase but its reaction rate is slower and a considerable excess will be required if encapsulation occurs. Sedimentation of the resulting hydroxide sludge tends to be more rapid and may not require the use of a flocculant.

(2) *Removal as sulphide.* Owing to the inherent solubility of metal hydroxides, it may not be possible to reduce the metal contents to a very low concentration such as 0.1 mg/l by precipitation as metal hydroxides. In this case, it may be necessary to precipitate the metals as insoluble sulphides. The principle of sulphide precipitation is that the solubilities of metal sulphides are generally much lower than the hydroxides. The theoretical solubilities of metal hydroxides and sulphides are shown in Table 4<sup>4</sup>. Hence, by forming metal sulphides, the metal concentrations in a wastewater can substantially be reduced to very low levels.

The sulphide reagent may be added in form of soluble sodium sulphide or insoluble ferrous sulphide. This removal method, however, suffers from some operational difficulties such as less settleable sludge and the need for control of addition of reaction chemicals.

(3) *Destruction of complexes and precipitation.* Some of the metal finishing operations may involve the use of complexing agents. The wastewater discharged from these operations may therefore contain complexed metal species which are often found to be unamenable to conventional treatment methods such as hydroxide precipitation. To effect metal removal the complexes would have to be broken but a ready treatment method to destroy the complexes does not exist. Depending upon the type of complex ions concerned the measures that may be applicable for metal complex destruction are dilution, oxidation, etc.

An example of dilution to result in destruction of metal complexes is in the treatment of ammonium

TABLE 4. THEORETICAL SOLUBILITIES OF HYDROXIDES AND SULPHIDES OF HEAVY METALS IN PURE WATER

Metal	Solubility of metal ion (mg/l)	
	As hydroxide	As sulphide
Cadmium (Cd <sup>++</sup> )	$2.3 \times 10^{-5}$	$6.7 \times 10^{-10}$
Chromium (Cr <sup>+++</sup> )	$8.4 \times 10^{-4}$	No precipitate
Cobalt (Co <sup>++</sup> )	$2.2 \times 10^{-1}$	$1.0 \times 10^{-8}$
Copper Cu <sup>++</sup> )	$2.2 \times 10^{-2}$	$5.8 \times 10^{-18}$
Iron (Fe <sup>++</sup> )	$8.9 \times 10^{-1}$	$3.4 \times 10^{-5}$
Lead (Pb <sup>++</sup> )	2.1	$3.8 \times 10^{-9}$
Manganese (Mn <sup>++</sup> )	1.2	$2.1 \times 10^{-3}$
Mercury (Hg <sup>++</sup> )	$3.9 \times 10^{-4}$	$9.0 \times 10^{-20}$
Nickel (Ni <sup>++</sup> )	$6.9 \times 10^{-3}$	$6.9 \times 10^{-8}$
Silver (Ag <sup>+</sup> )	13.3	$7.4 \times 10^{-12}$
Tin (Sn <sup>++</sup> )	$1.1 \times 10^{-4}$	$3.8 \times 10^{-8}$
Zinc (Zn <sup>++</sup> )	1.1	$2.3 \times 10^{-7}$

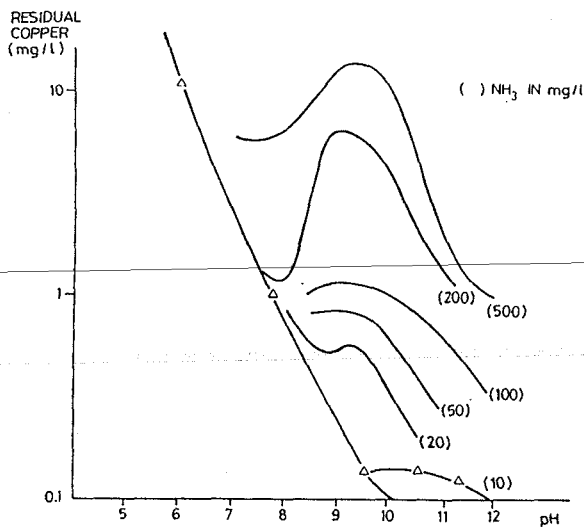

Fig. 10. Effect of residual ammonia concentration on copper removal

persulphate solution which is generated during the surface treatment of printed circuit boards. In this solution up to 5% copper is dissolved in the ammoniacal complexed form. By using hydroxide precipitation method little removal of copper can be achieved, even by adjusting the pH to 13. Instead, copper removal can be effected simply by providing dilution to reduce the ammonium concentration in the solution. Fig. 10 illustrates the effect of dilution on copper removal from spent ammonium persulphate solution.

## CONCLUSIONS

- (1) The electroplating wastewater generally contains chemicals that are toxic in nature and adequate treatment has to be provided to safeguard the receiving water bodies.
- (2) For an electroplating shop that needs to control its waste, it is beneficial to the shop to re-examine its manufacturing processes in order to minimize the pollution discharge. This may involve the change of plating bath composition, use of better rinsing methods, etc.
- (3) With respect to wastewater treatment, there is no universal treatment method that can encompass the specific characteristics of wastewater and constraints of every plating shop. It will definitely be advantageous for an electroplater to engage the services of a consulting engineer to carry out treatability tests on the wastewater of concern to establish the most cost-effective treatment solutions.

## REFERENCES

- <sup>1</sup>Handbook of Chemistry and Physics. 50th Ed., Chemical Rubber Co., Cleveland, Ohio, 1963.
- <sup>2</sup>Handbook of Analytical Chemistry. McGraw-Hill, New York, 1963.
- <sup>3</sup>HOENESS and JOHNSON. *Ionic Equilibrium as Applied to Qualitative Analyses*. Holt Rinehart & Winston Co., New York, 1954.
- <sup>4</sup>LANOQUETTE, K. H. Heavy Metals Removal. *Chem. Engineering*, Oct, 1977, Deskbook Issue. 73.