

TABLE OF CONTENTS

SI No	Contents	Page No.
1	Basic Textile wet Processing Terms	1
2	Sequence of operations in Wet processing	2
3	Brief Note on fabric mercerising machine	3
4	Details of fabric mercerising machine	5
5	Operating fabric mercerising machine	9
6	Instructions during shift changing	15
7	Importance of Health & Safety aspects	16

1. BASIC TEXTILE WET PROCESSING TERMS:

ABSORBENCY: The ability of one material to take up another material.

BLEACHING: It is a process to remove the natural and artificial impurities in fabrics to obtain clear white for finished fabric or in preparation for dyeing and finishing.

CHEESE: A cylindrical package of yarn wound on a flangeless tube.

DENSITY: The mass per unit volume

DYEING: It is a process of coloring fibers, yarns, or fabrics with either natural or synthetic dyes.

DYES: Substances that add color to textiles.

EFFLUENT: Waste water released after pretreatment, dyeing & finishing of Textile.

FINISHING: It includes various operations such as heat-setting, napping, embossing, pressing, calendaring, and the application of chemicals that change the character of the fabric.

LUSTER: The quality of shining with reflected light on textile material.

pH: Value indicating the acidity or alkalinity of a material.

PIGMENT: An insoluble, finely divided substance, used to color fibers, yarns, or fabrics.

SOFTENER: A product designed to impart soft mellowness to the fabric.

YARN: A generic term for a continuous strand of textile fibers, filaments, or material in a form suitable for knitting, weaving, or otherwise intertwining to form a textile fabric.

YARN COUNT: Yarn count is the numerical expression of yarn, which defines its fineness or coarseness. (Linear density).

2. SEQUENCE OF OPERATIONS IN WET PROCESSING

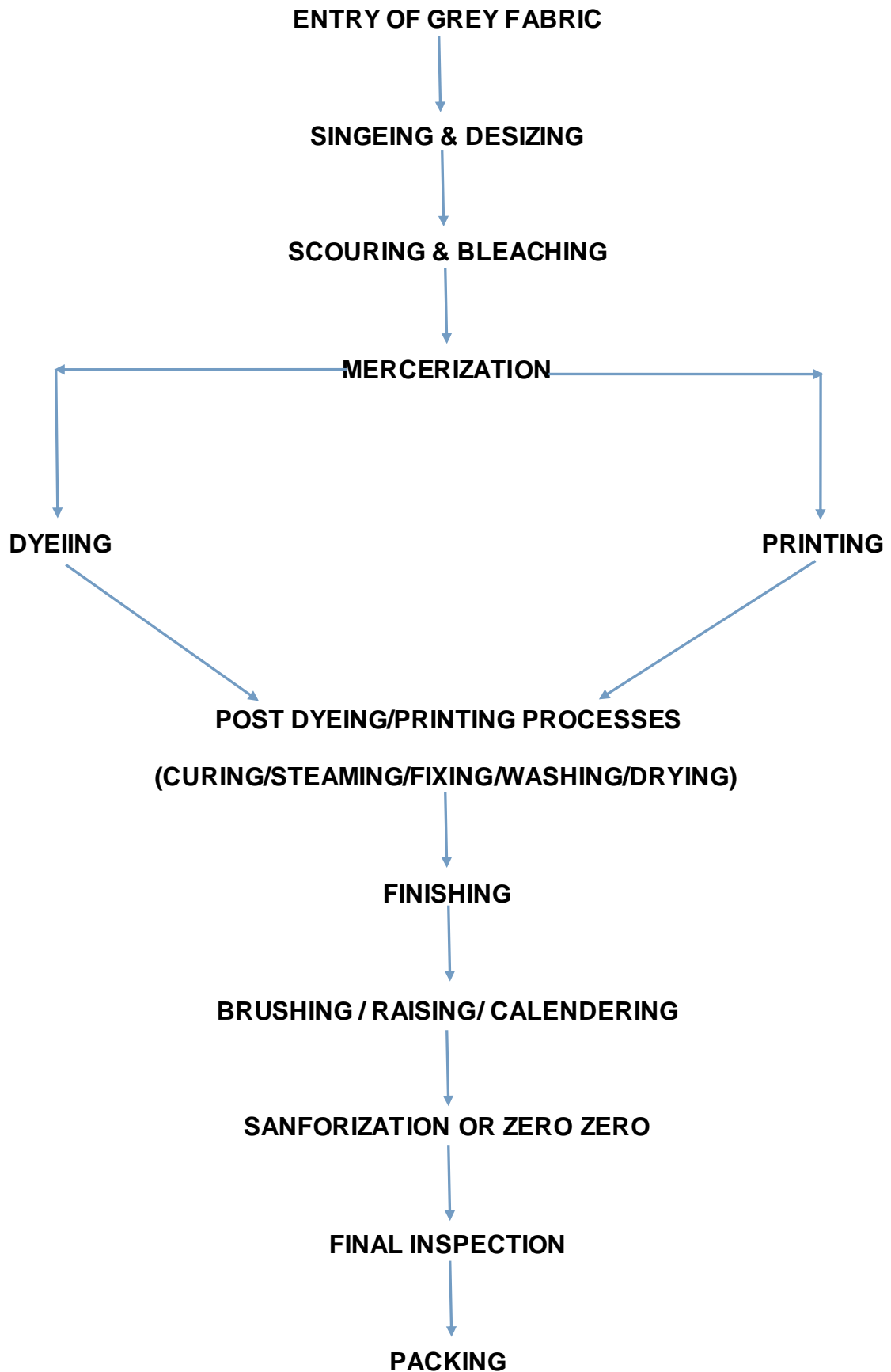

3. BRIEF NOTE ABOUT FABRIC MERCERIZATION MACHINE:

Mercerization and its importance:

Impregnation of Cotton, in the form of yarn or fabric, with sodium hydroxide solution (caustic soda) at a concentration in the range 200-220 gpl (grams per litre) at 20°C or 60°C under certain tension is called mercerisation.

The following properties are improved after mercerization:

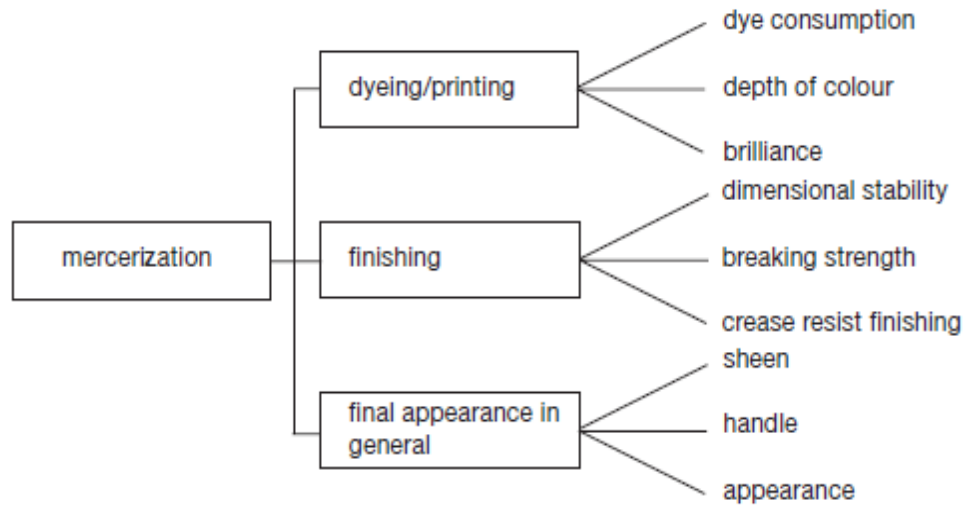

Types of fabric mercerization:

1. Chain mercerization machine
2. Chainless mercerization machine

Chain Mercerizing

Chain mercerizing is done on a range equipped with stenter chains for tension control. The range consists of a pad mangle followed by a set of timing cylinders and then a clip stenter frame.

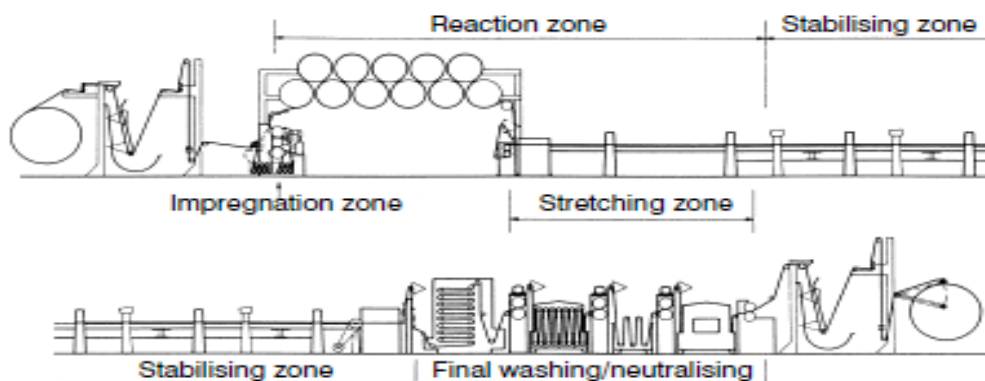

Fresh water is sprayed onto the fabric to remove the caustic soda as it is held tensioned in the stenter frame. The stenter frame is followed by a series of open-width wash boxes which further reduces the caustic level. Acetic acid is in one of the last boxes to complete the neutralization of caustic.

Chainless Mercerizing

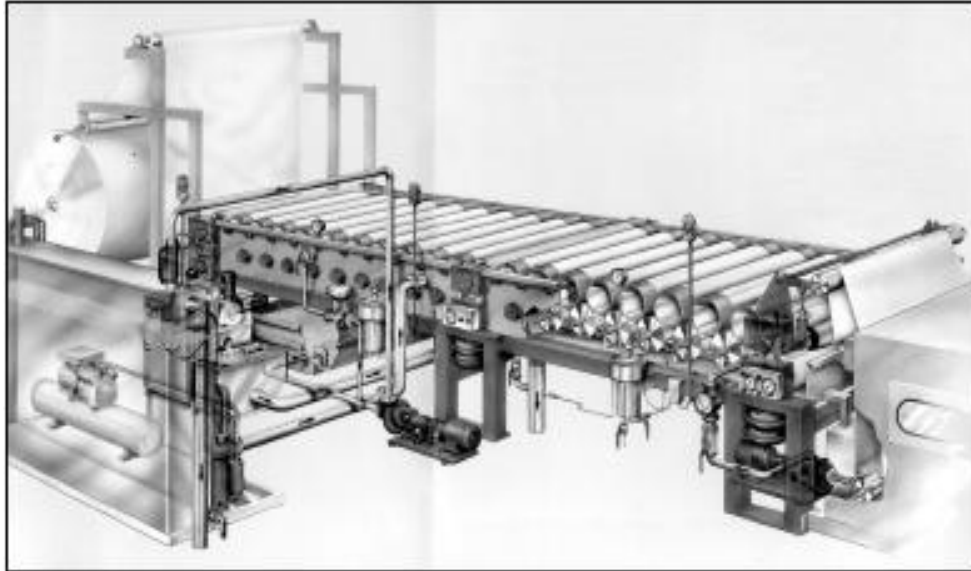

Passage of fabric in chainless mercerization machine

Chainless mercerizing is practiced on a range where the cloth is maintained in contact with rotating drums virtually throughout the entire process.

Steps involved in mercerization machine:

- ❖ Apply 200 to 220 gpl of caustic at the pad mangle at 100% wet pickup.
- ❖ Pass fabric over timing cylinders.
- ❖ The number of cylinders must correspond to the range speed and provide at least one minute dwell time.
- ❖ Clip fabric onto stenter chains and stretch weft wise.
- ❖ Run fabric under spray washers to remove caustic.
- ❖ Release tension and continue washing in open-width wash boxes, to further reduce the caustic.
- ❖ Neutralize with acetic acid and dry the fabric.

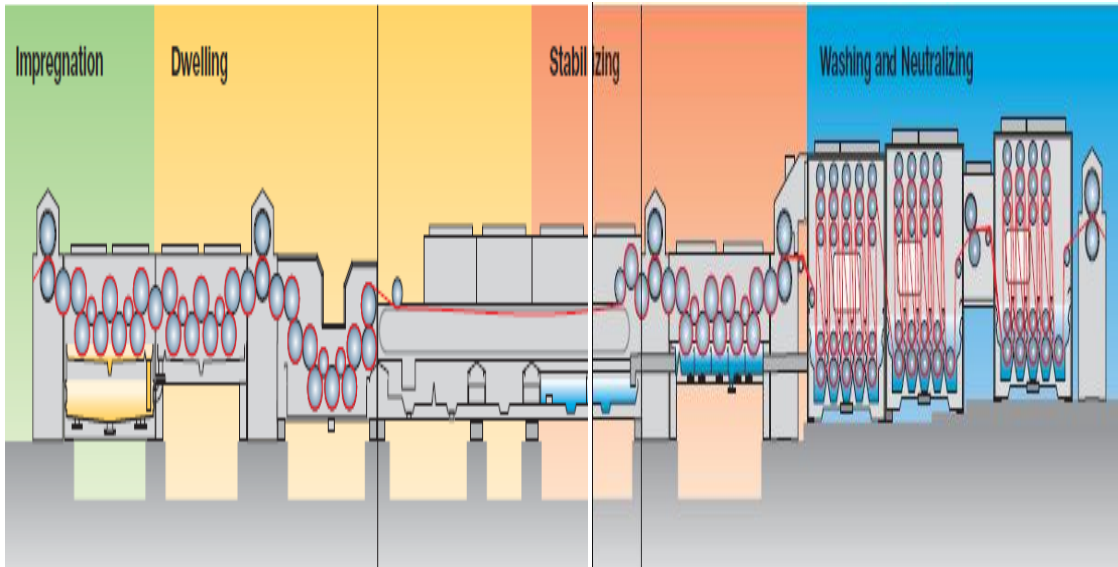

Fabric flow in Mercerization machine

4. Details of fabric mercerising machine:

Inlet J-Scray: - To collect the fabric during batch changing to avoid machine stoppage by using tensioner roller, pressure roller and compensator.



Description of the fabric infeed with chute and batch change

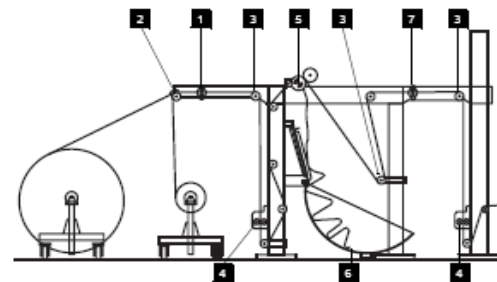

- 1 Tensioning knob with crank
- 2 Guide roll with brakes
- 3 Guide roll
- 4 Fabric guide
- 5 Feeding device 20 - 30 kN
- 6 Chute
- 7 Electro magnetic fabric brakes or 3-phase voltage control

Impregnation Unit:

It contains two compartments; both are filled with caustic soda solution with required concentration. The fabric is dipped into the caustic soda solution and finally squeezes out the excess caustic at the end of this unit.

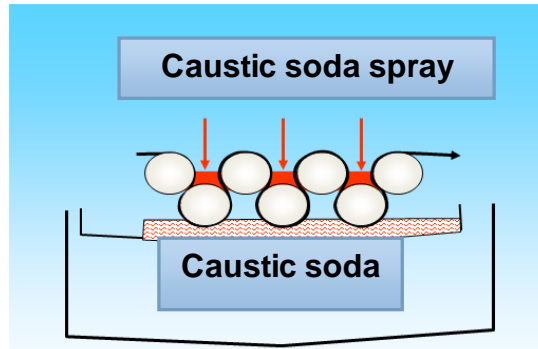

Impregnating unit

Timing Cylinders:

It consists of series of steel roller, the fabric passes under tension in rollers and thus reaction between fabric and caustic soda take place.

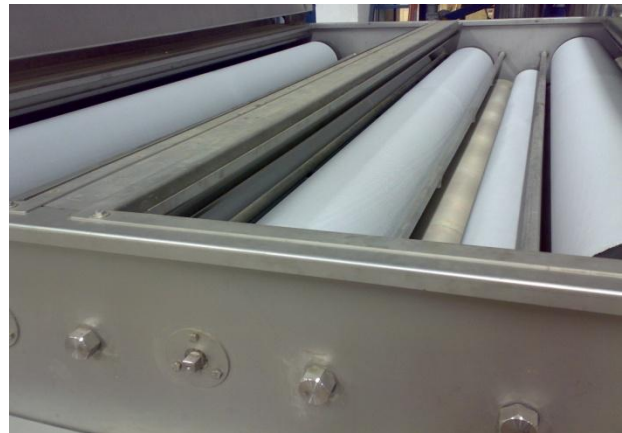

Stenter unit:

It consists of chain drive and spraying unit. To get the required width of the fabric by using the Stenter chain track and to remove the excess caustic soda by spraying water. (Below figure shows stenter unit).



Washing and Neutralizing Compartment:

In this compartment it washes the excess caustic soda present in the fabric by using hot water.

And in the neutralizing compartment fabric pH is corrected by dosing of mild Acetic acid and then washing the excess acid.

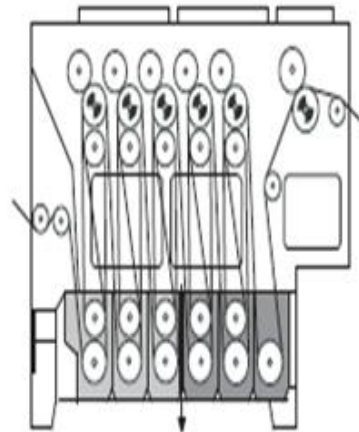
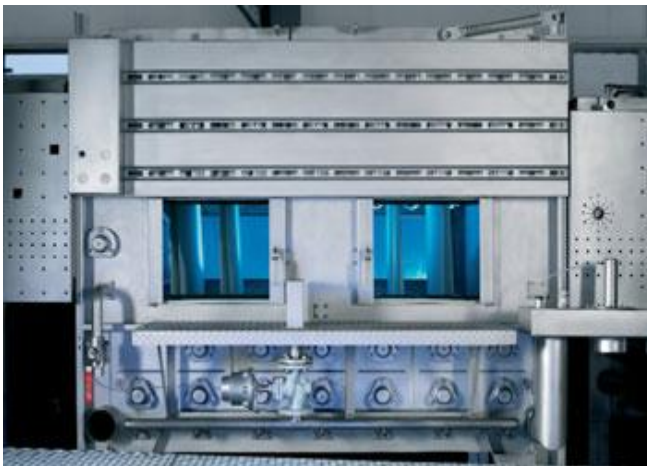

Washing and neutralizing compartment and fabric passage

Vertical Drying Range: It consists of Teflon and stainless steel cylinders. The steam is passed inside the cylinder. When the fabric is passed over the cylinder the actual drying happens on the fabric.



Vertical Drying Range

Outlet unit: To collect the fabric during batch change to avoid machine stoppage and to provide perfect out batch of fabric without any crease.

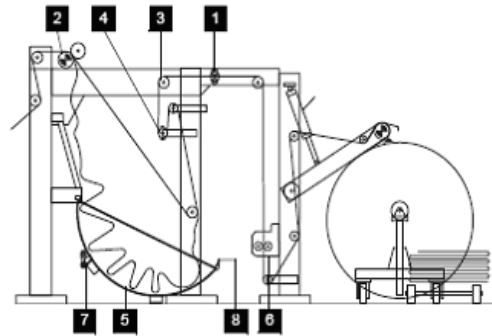

With chute to change batches without stopping the system

- | | |
|--|---------------------------|
| 1 Tensioning knob (electromagnetic) | 5 Chute (accumulator) |
| 2 Pneumatic feeding device max. 5kN | 6 Fabric selvedge guiders |
| 3 Traversing roll with axle | 7 Photocell |
| 4 Oscillating roll with pneumatic system | 8 Reflector |

5. OPERATING OF FABRIC MERCERISING MACHINE:



Find out the exact batch & lot card



placing the selected batch in the machine



Switch ON the Main power



Open the steam, air and water valve

Main operating panel

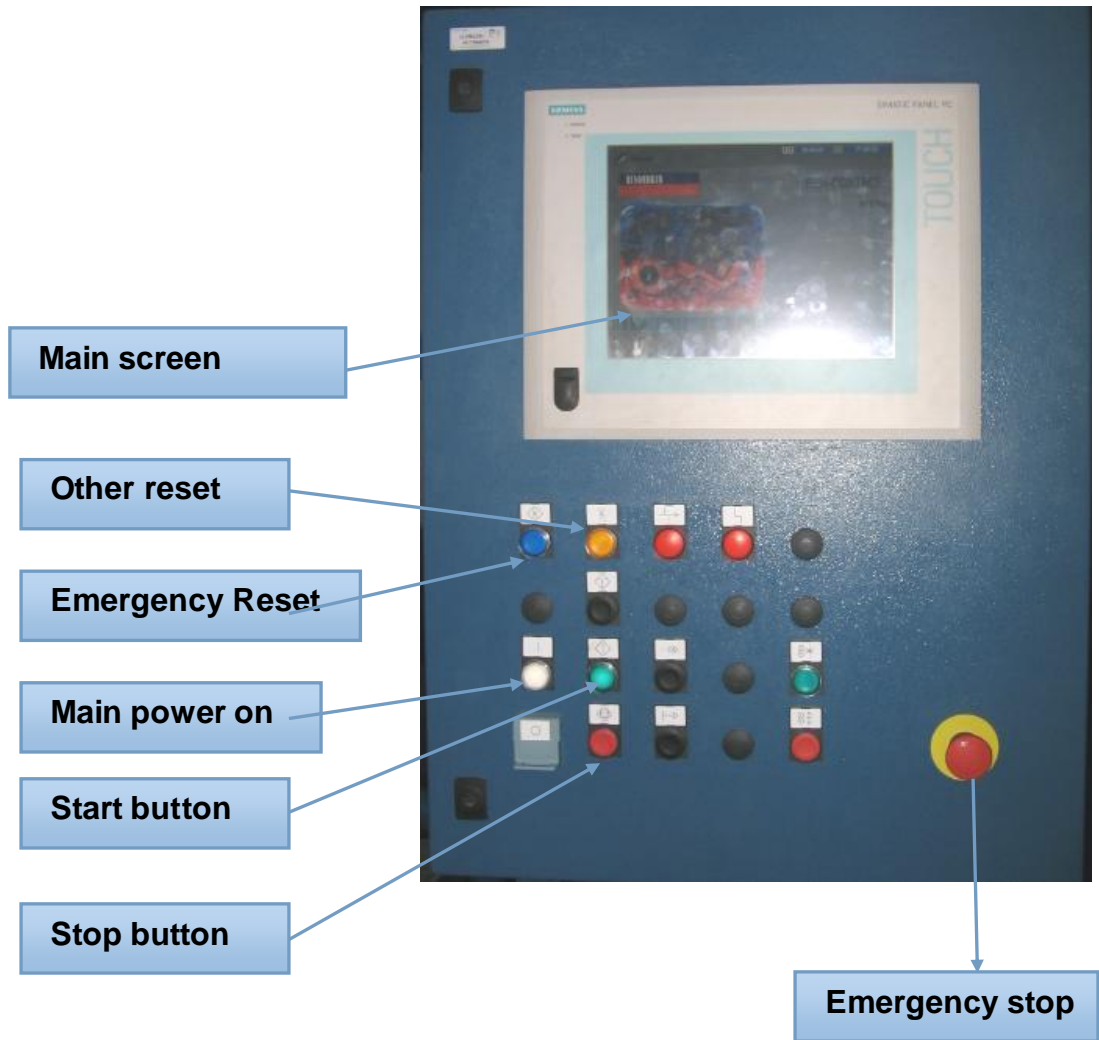

Machine control panel

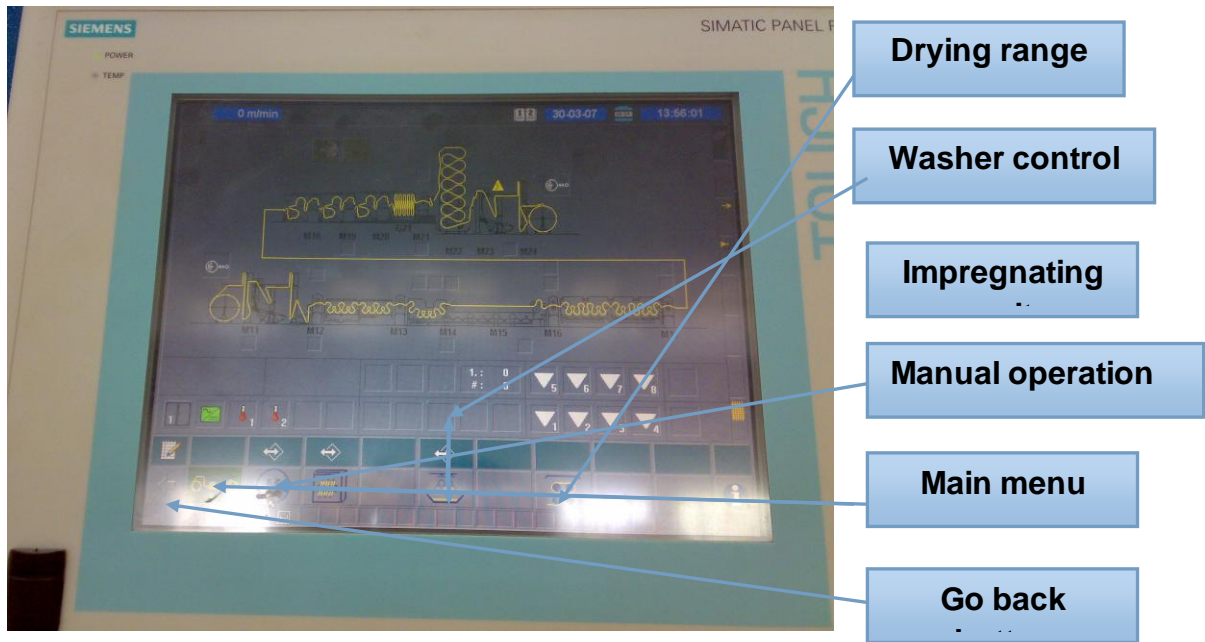

Impregnation Control screen

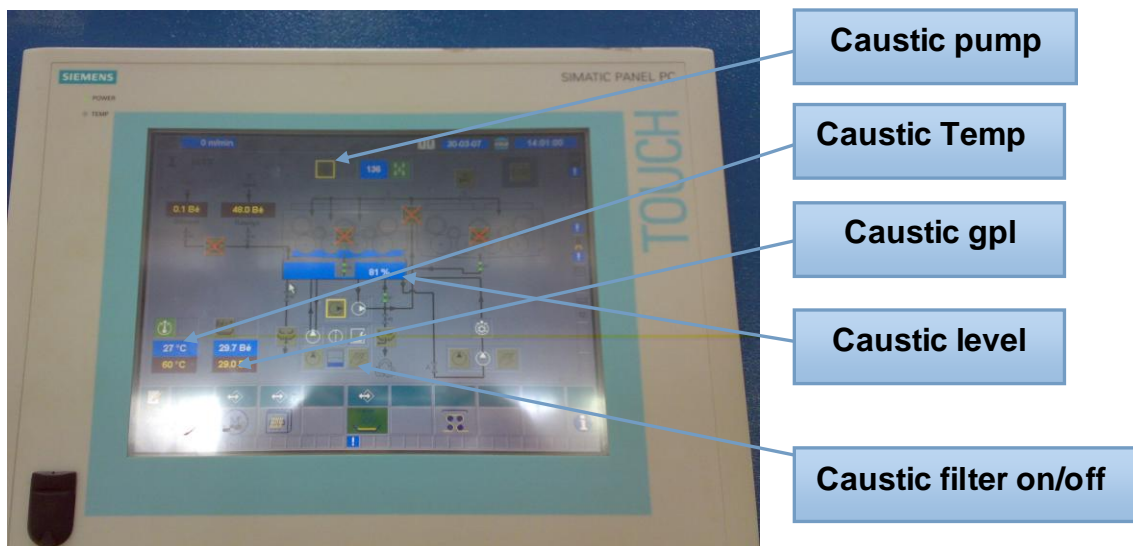

Stenter tension control:



Tight & slack control

Emergency off



Caustic soda tank



Acid dosing system



Setting the parameters



checking the fabric while running



Setting empty batch for winding



checking the final width of the fabric

- ❖ Understand and follow the instruction from lot card and programme book.
- ❖ Switch On main power and then open compressed air, water valve and steam.
- ❖ Check the quality and lot number of the fabric before putting on the machine by checking the label.

- ❖ Transport the fabric to be run, to the inlet J-scray of mercerization machine using hydraulic hand puller.
- ❖ Stitch the two ends without crease, (i.e.) one end of the fabric is to be mercerised and the other leader fabric in the machine and ensure straightness of fabric without crease.
- ❖ Fill the water in all the washers and set the temperature of all washing units.
- ❖ Set the concentration of the caustic soda and other parameters like speed of the machine, width etc.,
- ❖ Observe for any defect in the fabric before and during the process and report to the supervisor if any irregularities observed.
- ❖ Ensure that the Speed of the machine is same from starting to end of the process. (For normal mercerization operation requires 50-80 m/min (meters per min), it varies depends upon the quality. Light weight GSM fabric requires more speed and vice versa.)
- ❖ Check actual flow rate of each chemical from flow meter as well as the operating monitor.
- ❖ Keep the chemicals ready for entire process.
- ❖ Switch ON the circulating pump while starting the machine.
- ❖ Check the exit width of the fabric at every 500 meters.
- ❖ Check for any defects in the mercerised fabric like stains – dust, chemicals, rust, handling stains, crease, water dropping, oil, grease, etc.
- ❖ If the machine stops for long time, put the leader fabric on the machine and commence water spraying the impregnating unit immediately without delay.

Cleaning in mercerising machine:

- ❖ Remove regularly accumulated dust and dirt from the machine.
- ❖ All the rollers to be cleaned with dry fabric at starting and at the end of every programme.
- ❖ Clean the entire washer and its filter once in a day.
- ❖ Clean the Padding mangles properly and wash the trough thoroughly.
- ❖ Collect all the waste and store them at designated place.

6. INSTRUCTIONS DURING SHIFT CHANGING:

Taking charge of duties while starting of shift:

- ❖ Come at least 10 - 15 minutes earlier to the work place.
- ❖ Meet the previous shift operator and discuss regarding the issues faced by them with respect to the quality or production or spare or safety or any other specific instruction etc.
- ❖ Understand the fabric being processed & process running on the machine.
- ❖ Ensure technical details are mentioned on the job card & display in machine.
- ❖ Check the next batch to be processed is ready near the machine.
- ❖ Check the cleanliness of the machines & other work areas.
- ❖ Question the previous shift operator for any deviation in the above and bring the same to the knowledge of the shift superior.

Handing over charge at the end of shift:

- ❖ Properly hand over the shift to the incoming operator.
- ❖ Provide the details regarding fabric quality & the process running on the machine.
- ❖ Provide all relevant information regarding the stoppages or breakdown in the machine, any damage to the material or machine.

- ❖ Ensure the next lot to be processed is ready near the machine
- ❖ Get clearance from the incoming counterpart before leaving the work spot.
- ❖ Report to the shift supervisor in case the next shift operator doesn't report for the shift.
- ❖ Report to the shift supervisor about the quality / production / safety issues/ any other issue faced in the shift and leave the department only after getting concurrence for the same from superiors.
- ❖ Collect the wastes from waste bags weigh them & transport to storage area.

7. IMPORTANCE OF HEALTH AND SAFETY:

- ❖ Use and maintain personal protective equipment such as Hand Gloves, Gum Boots, head cap etc., as specified.
- ❖ Never handle chemicals with bare hands
- ❖ Report to the supervisor any service malfunctions in the machine that cannot be rectified.
- ❖ Store materials and equipment at their designated places.
- ❖ Minimize health and safety risks to self and others due to own actions.
- ❖ Monitor the workplace and work processes for potential risks.
- ❖ Do not carry any metallic parts during machine running as there are chances of fire and damage to machine parts.
- ❖ Take action based on instructions in the event of fire, emergencies or accidents and participate in mock drills/ evacuation procedures organized at the workplace as per the organization procedures.