

TABLE OF CONTENTS

Sr No	Contents	Page No.
1.	Basics of Knitting	1
2.	About circular knitting machine operations	2
3.	Operating circular knitting machines (steps involved)	2
4.	Material flow in circular knitting machine	3
5.	Operations involved in circular knitting machine	9
6.	Operating the circular knitting machine	12
7.	Take off the fabric roll in the circular knitting machine	12
8.	Knitting defects causes and remedies	15
9.	Cleaning and waste disposal	21
10.	Shift interchange	21
11.	Health & safety	22

BASICS OF KNITTING

Knitting is the intermeshing or inter-looping of single yarn or single set of yarns to produce knitted fabric. Knitting is a process of manufacturing a fabric by intermeshing of loops of yarns.

There are mainly two basic knit structures viz. Weft knitting and Warp knitting as detailed in the below table.

Warp Knits	Weft Knits
Tricot Knit	Plain Jersey Knit
Raschel Knit	Purl Knit
Crochet Knit	Rib Knit
Milanese Knit	Patterned Knits
	Double Knits

There are mainly two types of weft knit machines viz. circular knitting and Flat bed knitting.

ABOUT CIRCULAR KNITTING MACHINE OPERATIONS:



- In Circular knitting machines, yarn package in the form of cones / chesses are fed for knitting.

Circular Knitting machine Objectives:

- To produce knitted fabric from the yarn fed by knitting of the yarn.

OPERATING CIRCULAR KNITTING MACHINES (Steps Involved)

Important Zones in Knitting Machine

- Creeling zone
- Knitting zone
- Fabric Zone

Material Flow in Circular Knitting Machine:

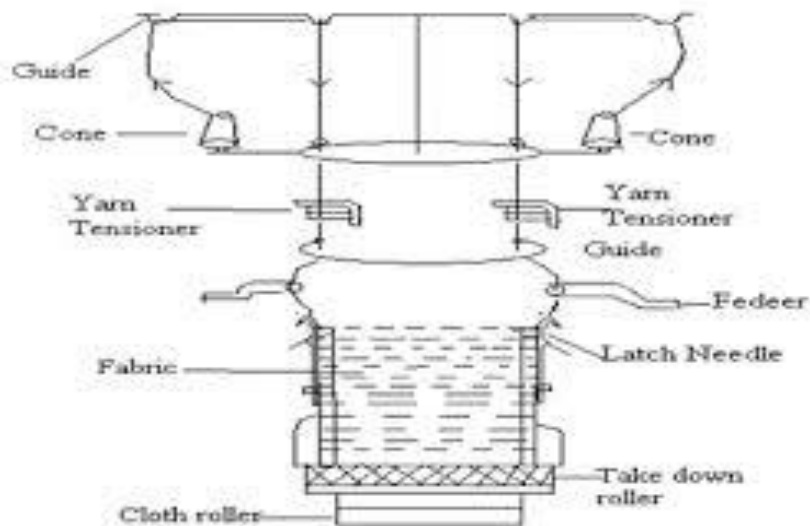

The yarn is fed from the yarn package through the yarn guide, yarn tensioner, guide, feeder to the knitting elements for knitting as shown in the diagram. After the knitting of fabric, it is wound on to the cloth roller through the take down roller.

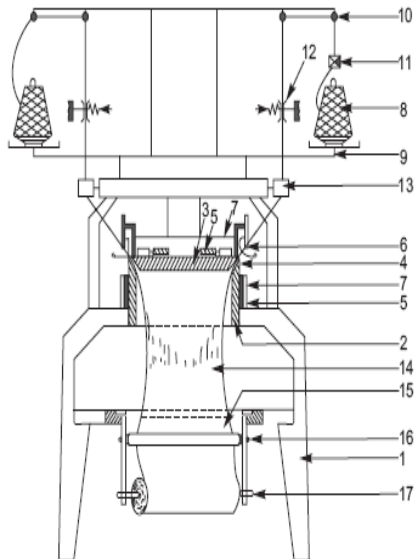

- 1 – Legs
- 2 – Cylinder
- 3 – Dial
- 4 – Needle
- 5 – Cam Parts
- 6 – Feeder guide
- 7 – Cam
- 8 – Supply Package
- 9 – Creel
- 10 – Top Stop motion
- 11 – Anti Snarl Device
- 12 – Tensioner
- 13 – Positive feeder
- 14 – Knitted fabric
- 15 – Fabric spreader
- 16 – Fabric withdrawal roller
- 17 – Fabric winding roller

Creel: Creel is a part of a knitting machine.

Here yarn package are stored and ready to feed in the machine.

VDQ Pulley: It is a very important part of the machine. It controls the quality of the product. Altering the position of the tension pulley changes the G.S.M. of the fabric.

If pulley moves towards the positive direction then the G.S.M. will decrease. And in the reverse direction G.S.M will increase.



Pulley Belt: It controls the rotation of the MPF wheel.



Brush: Its clean the pulley belt.



Tension Disk: It confronts the tension of the supply yarn.



Inlet and Outlet Stop Motion: It is an important part of



the machine. It stops the machine instantly when a yarn breaks.

Yarn Guide: It helps the yarn to feed in the feeder.



MPF: It is Mamenger positive feed. It is also an important part of the machine. It's give positive feed to the machine



Feeder Ring: It is a ring. Where all feeders are pleased together.



Disk Drum: Use in jacquard machine to produce various types of design.



Pattern Wheel: Pattern Wheel use in Pai Lung and Auto Stripe machine because of that that help to produce various types of design and stripe.

Feeder: Feeder is help yarn to feed in to the machine.



Needle Track: Where all Needles is placed together in a decent design.

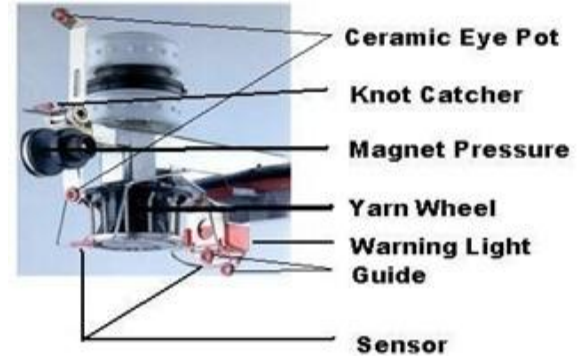

Needle: It is a principal element of the knitting machine. Its help the yarn to create a loop. And by this way fabric are produce. Prior to yarn feeding the needle is raised to clear the old loop from the hook, and received the new loop above it on needle stem. The new loop is then enclosed in the needle hook as the needle starts to descend.



Sinker: It is most important element of the machine. Its help to loop forming, knocking over and holding down the loop.

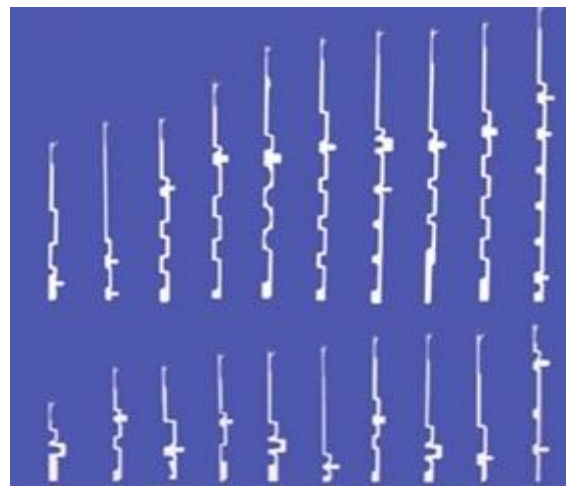

Sinker Ring: Sinker ring is a ring. Where all sinkers are placed together.



Cam Box: Where the cam are set horizontally.



Cam: Cam is device s which converts the rotary machine drive in to a suitable reciprocating action for the needles and other elements.



Cylinder: Needle track are situated hear.

Cylinder Balancer: It helps the cylinder to set in a proper alignment.

Uniwave Lubrication: The Uniwave lubricator provides uniform lubrication to needles, cam tracks, lifters and other knitting machine components. The patented nozzle construction separates the air-oil mixture into air and droplets of oil.



Adjustable Fan: This part removes lint, hairy fibre from yarn and others. To clean the dust by air flow.



Expander: To control the width of the knitted fabric. No distortion of the knitting courses. Even take down tension in the knitting machine. As a result, an even fabric structure is achieved over the entire fabric width. The deformation of the knitted fabric goods can be reduced.

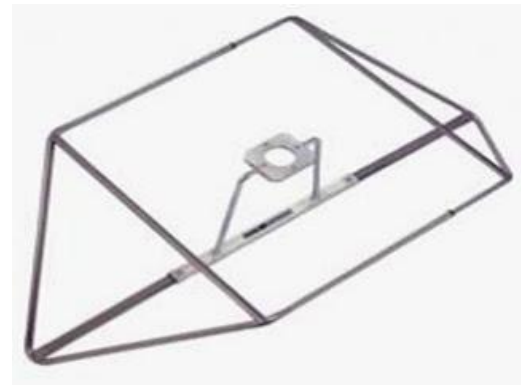

Needle Detector: This part detect the any type of faults of needles.



Air Gun Nozzle: To feed the yarn; sometimes it is used for cleaning purpose.



Operations involved in circular knitting machine

Creeling and knotting

- Creel the required number of cones / chesses.
- Ensure proper creeling procedure is followed for creeling the cones / chesses.
- Check the cones / chesses for visual defects and signs of improper winding while creeling.
- Unwind the yarn from cone.
- Ensure the yarns are passed through all guide rollers / yarn path and ends are joined according to the work procedure.
- Draw the yarn through the guide, guide rollers and pass it through the stop motion, positive feeder in delivery zone
- Ensure proper knotting.
- Ensure proper functioning of knitting machine post knotting.
- Collect the wastes collected during knotting and store the waste at respective waste box.
- Ensure standard knotting procedure is adopted and quality of knotting is as per standards
- Ensure minimum time is taken for knotting the yarn.
- Ensure safety while carrying out knotting activity.
- Verify the quality of knotting done in the yarn.
- Ensure yarn tension in the creeling section is appropriate.
- Ensure proper functioning of the machine.

Mending broken thread

1 Thread breaks and machine stops



2 Broken thread is identified



3 Broken thread is knotted



4 Broken thread is knotted



Replacing empty cone

1 cone exhausts and machine stops



2 new cone for creeling



3 new cones creeled



4 Yarn passed through guides

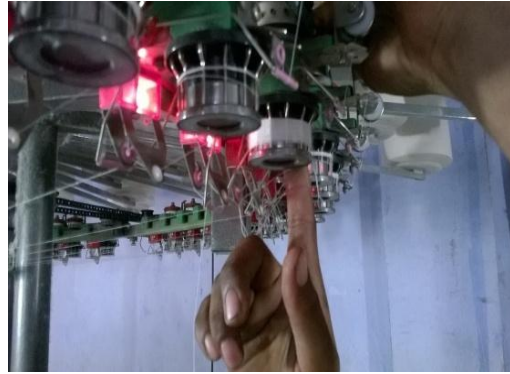

5 Yarn passed through guides



6 Machine starts



OPERATING THE CIRCULAR KNITTING MACHINE

- Obtain necessary instructions from the supervisor.
- Start the machine.
- Operate the control switches for starting and stopping the knitting machine.
- Follow the different signal lamps used in machines.
- Ensure proper functioning of machine by verifying in the display panel.
- Ensure proper knotting of the yarn the during yarn breakage.
- Ensure the machines are operated in accordance with workplace procedures.
- Ensure the yarns are run through correct yarn-paths at operating tensions according to machine-builder's instructions and workplace procedures.
- Ensure the production is monitored for faults and variations notified, in accordance with workplace procedures.

- Ensure the machines are monitored for continuous functioning of all systems and variations notified, in accordance with workplace procedures.
- Ensure the production is removed from machines in accordance with workplace procedures.
- Ensure the machines are lubricated as directed in accordance with workplace procedures.
- Ensure the yarn paths, eyelets, knitting heads, machines, and working environment are clean and free of contamination in accordance with workplace procedures.
- Check whether the yarns are properly fed in the knitting machine.
- Knot the yarn during breakage.
- View the display panel or signal and identify the reasons for machine stoppage, if any.
- ensure the knitting machine is running in the set speed by viewing the display panel
- Ensure the proper functioning of machine and problems if any should be noted and reported to Supervisor / Maintenance in- charge.

TAKE OFF THE FABRIC ROLL IN THE CIRCULAR KNITTING MACHINE

- Collect the empty cones from creel and replace with a full cone
- Ensure whether the fabric roll is ready for doffing by viewing the details in display panel or by manual
- Keep the empty fabric roller ready for replacement
- Keep the empty fabric roll near the knitting machine in manual doffing
- Doff the full fabric roll in case of manual doffing
- Ensure proper doffing procedure is followed
- Remove the fabric roll to the storage area
- Ensure the knitting machine is properly restarted after doffing
- Ensure proper functioning of knitting machine post fabric take off.
- Ensure proper identification by marking of roll no, lot no, dia, gauge, machine no, etc.
- Weigh the fabric roll and record the same in the production register.

Page No 12	RSA DOCUMENT
	Version No.01

- Store the doffed roll in the designated area by suitably covering the rolls to avoid soiling.

Changing broken needle

1 Needle breaks



2 screw loosened



3 Screw pulled out



4 Needle holder pulled out



5 broken needle removed

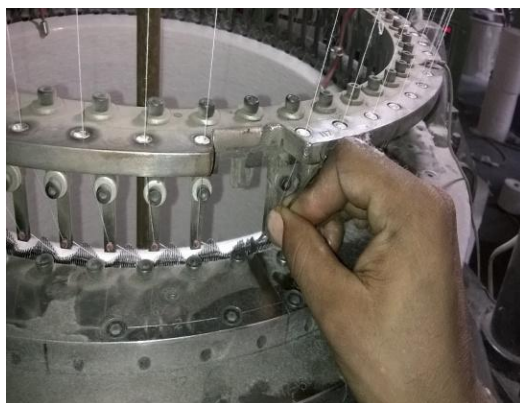

6 broken needle removed



7 new needle



8 new needle inserted



9 Needle holder assembled back



10 Needle holder assembled back



Knitting defects causes and remedies

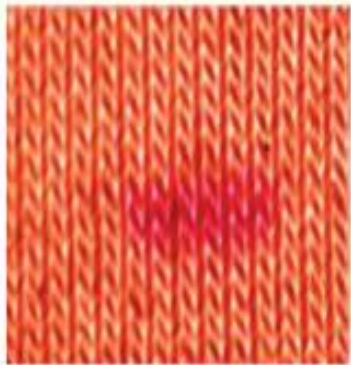
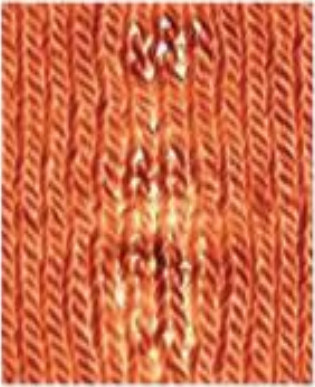

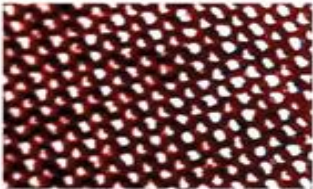



Table 1: Fabric faults related to yarn		
Fault description	Causes	Solutions
 <p>Unsettled fabric Local fault corresponding to a portion of yarn having a linear density quite lower or higher than the rest of the yarn.</p>	<p>Use of irregular yarns presenting an important level of long-period unevenness (thin, thick places and neps per km)</p>	<p>Yarn quality control: Application of an Uster test before knitting to measure the irregularity and imperfection level in used yarns</p>
 <p>Cotton contamination Dark stains, undetectable on grey cotton fabric and appearing after light dyeing.</p>	<p>Contamination of raw cotton by insects laying in the cotton flowers</p>	<ul style="list-style-type: none"> ◆ Impossible to remove ◆ Laboratory dyeing tests on lab knitted samples before knitting production permit to detect this fault and remove contaminated bobbins

Table 2: Fabric faults related to knitting

Fault description	Causes	Solutions
 <p data-bbox="220 689 395 723">Vertical stripes</p>	<ul style="list-style-type: none"> ◆ Defective needles or sinkers 	<ul style="list-style-type: none"> ◆ Needles and sinkers change after long time use ◆ Checking needle detectors ◆ Use of fabric fault detector
 <p data-bbox="220 1010 427 1043">Horizontal stripes</p>	<ul style="list-style-type: none"> ◆ Couliering or yarn consumption are not constant at all feeders 	<ul style="list-style-type: none"> ◆ Yarn consumption and couliering readjustment

 <p>Fabric spirality Distortion of plain knitted fabric. Wales are not perpendicular to courses.</p>	<ul style="list-style-type: none"> ◆ Yarn twist too high ◆ Number of feeder too high ◆ Bad combination between yarn twist direction and machine rotation direction 	<ul style="list-style-type: none"> ◆ Control of yarn twist (yarn twist should never be above 700 tr/m) ◆ Reduction of feeders number ◆ Use of Z-twist yarn with machines having needles watch rotation direction, and vice versa ◆ Appropriate finishing reduces fabric spirality
 <p>Dropped stitches Local column of dropped stitches obtained when presented yarn is occasionally unhooked by needles.</p>	<ul style="list-style-type: none"> ◆ Yarn-guide not properly set ◆ Defective needle latch ◆ Yarn tension is not sufficient or too long stitches ◆ Take-down too high ◆ Cylinder-dial distance too high ◆ Wrong yarn threading 	<ul style="list-style-type: none"> ◆ Precise yarn-guide resetting ◆ Needle change ◆ Yarn consumption and coultering readjustment ◆ Take-down readjustment ◆ Dial position readjustment ◆ Yarn threading through the right bore ◆ Use of fabric fault detector ◆ This fault can be corrected by stitches reforming using a simple needle
 <p>Holes Local holes obtained when yarn breaks during loop formation.</p>	<ul style="list-style-type: none"> ◆ Presence of knots in yarn ◆ Weak places in yarn ◆ Yarn tension too high ◆ Yarn too dry ◆ Yarn-guide not properly set ◆ Yarn guide blocked by yarn hair accumulation 	<ul style="list-style-type: none"> ◆ Use of flat knots ◆ Yarn regularity control ◆ Yarn consumption and coultering readjustment ◆ Air humidification ◆ Precise yarn-guide resetting ◆ Use of yarn having lower hairiness, bobbins and yarn-guide blowing, use of protective filter creel ◆ Use of fabric fault detector

 <p>Yarn hair deposit Yarn hair and other yarn wastes deposit on needles fabric during knitting.</p>	<ul style="list-style-type: none"> ◆ Inappropriate air blowing ◆ Use of yarn with high hairiness ◆ Different machines working with different yarn types in the same place 	<ul style="list-style-type: none"> ◆ Readjustment of CKM blowing frequency and intensity ◆ Use of yarn having lower hairiness, bobbins and yarn guide blowing, use of protective filter creel ◆ Machines separation with partitions
 <p>Knots Knot appearance on fabric.</p>	<ul style="list-style-type: none"> ◆ Inappropriate yarn knotting 	<ul style="list-style-type: none"> ◆ Use of flat knots ◆ Use of fabric fault detector

 <p>Fabric fall-out Local dropped fabric obtained when big number of successive needles lose stitches.</p>	<ul style="list-style-type: none"> ◆ Yarn rupture in yarn-guide due to weak places in yarn or yarn hair accumulation ◆ Stitches rupture due to excessive take-down or weak places in yarn ◆ Defective yarn feeder ◆ Yarn tension too high ◆ Yarn-guide not properly set ◆ Defective needles or sinkers 	<ul style="list-style-type: none"> ◆ Yarn control before knitting. Use of yarn having lower hairiness, bobbins and yarn-guide blowing, use of protective filter creel ◆ Take-down readjustment ◆ CKM elements checking ◆ Yarn consumption and couliering readjustment ◆ Precise yarn-guide resetting ◆ Needles and sinkers change after long time use ◆ Regular machine cleaning
 <p>Oil stains Local lubricating machine oil stains visible after fabric finishing.</p>	<ul style="list-style-type: none"> ◆ Inadequate oil ◆ Defective oiling circuit ◆ Excessive oiling 	<ul style="list-style-type: none"> ◆ Use of adequate oil, respect of oil washing recommendations (temperature, grey fabric storage duration) ◆ Regular oiling circuit checking ◆ Oiling quantity readjustment
 <p>Missing yarn Regular absence of yarn that</p>	<ul style="list-style-type: none"> ◆ Wrong yarn threading ◆ Defective yarn feeder ◆ Yarn rupture in yarn-guide due to weak places in yarn or yarn hair accumulation 	<ul style="list-style-type: none"> ◆ Yarn threading through the right bore ◆ CKM elements checking ◆ Yarn control before knitting. Use of yarn having lower hairiness, bobbins and yarn-guide blowing, use of protective filter creel ◆ Regular machine cleaning ◆ Use of fabric fault detector

 <p>Foreign yarn Regular coloured stripes that appear after dyeing when a foreign yarn different from normally used yarn is accidentally introduced.</p>	<ul style="list-style-type: none"> ◆ Workers carelessness ◆ Presence of different yarn types having the same colour on the same creel 	<ul style="list-style-type: none"> ◆ Workers training to recognise different yarn types ◆ Rigorous yarn sorting and storage
 <p>Elastomeric misplating Regular absence of elastane yarn.</p>	<ul style="list-style-type: none"> ◆ Defective elastane yarn feeder ◆ Elastane roll-guide not properly set 	<ul style="list-style-type: none"> ◆ CKM elements checking ◆ Elastane roll-guide resetting ◆ Use of fabric fault detector
 <p>Side crease Circular knitted fabrics containing elastane give rise to problems in as far as the side crease created when winding up a tube of circular knitted fabric is fixed within a short period and can no longer be removed. This fault appears after finishing.</p>	<ul style="list-style-type: none"> ◆ High pressure exerted by take-down rolls on tubular fabric inducing permanent deformation of elastane fibres at fabric sides ◆ Too long tubular grey fabric storage ◆ Use of ordinary take-down devices with elastane plated fabrics 	<ul style="list-style-type: none"> ◆ Use of take-down rolls with movable side rubber rings to avoid pressure on fabric sides ◆ Short grey fabric storage ◆ Use of open width take-down devices

Table 3: Fabric faults related to finishing



Fault description	Causes	Solutions
 <p>Fabric pilling</p>	<ul style="list-style-type: none"> ◆ Use of yarn with high hairiness ◆ Frictions undergone by fabric in dyeing machines 	<ul style="list-style-type: none"> ◆ Use of yarn having lower hairiness ◆ Use of anti-pilling agents ◆ Checking rolling organs outer surface of finishing machines
 <p>requested obtained</p> <p>Colour non-conformity</p>	<ul style="list-style-type: none"> ◆ Error in dyeing process 	<ul style="list-style-type: none"> ◆ Lab dyeing before production
 <p>Colour non-uniformity</p>	<ul style="list-style-type: none"> ◆ Error in dyeing process 	<ul style="list-style-type: none"> ◆ Respect of dyeing process

Table 3: Fabric faults related to finishing

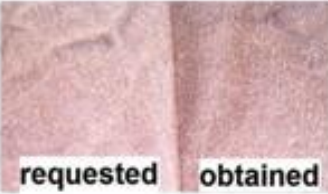

Fault description	Causes	Solutions
 <p>Fabric pilling</p>	<ul style="list-style-type: none"> ◆ Use of yarn with high hairiness ◆ Frictions undergone by fabric in dyeing machines 	<ul style="list-style-type: none"> ◆ Use of yarn having lower hairiness ◆ Use of anti-pilling agents ◆ Checking rolling organs outer surface of finishing machines
 <p>requested obtained</p> <p>Colour non-conformity</p>	<ul style="list-style-type: none"> ◆ Error in dyeing process 	<ul style="list-style-type: none"> ◆ Lab dyeing before production
 <p>Colour non-uniformity</p>	<ul style="list-style-type: none"> ◆ Error in dyeing process 	<ul style="list-style-type: none"> ◆ Respect of dyeing process

Table 3: Fabric faults related to finishing



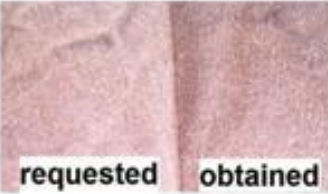

Fault description	Causes	Solutions
 <p>Fabric pilling</p>	<ul style="list-style-type: none"> ◆ Use of yarn with high hairiness ◆ Frictions undergone by fabric in dyeing machines 	<ul style="list-style-type: none"> ◆ Use of yarn having lower hairiness ◆ Use of anti-pilling agents ◆ Checking rolling organs outer surface of finishing machines
 <p>requested obtained</p> <p>Colour non-conformity</p>	<ul style="list-style-type: none"> ◆ Error in dyeing process 	<ul style="list-style-type: none"> ◆ Lab dyeing before production
 <p>Colour non-uniformity</p>	<ul style="list-style-type: none"> ◆ Error in dyeing process 	<ul style="list-style-type: none"> ◆ Respect of dyeing process

Table 3: Fabric faults related to finishing		
Fault description	Causes	Solutions
 <p>Fabric pilling</p>	<ul style="list-style-type: none"> ◆ Use of yarn with high hairiness ◆ Frictions undergone by fabric in dyeing machines 	<ul style="list-style-type: none"> ◆ Use of yarn having lower hairiness ◆ Use of anti-pilling agents ◆ Checking rolling organs outer surface of finishing machines
 <p>requested obtained</p> <p>Colour non-conformity</p>	<ul style="list-style-type: none"> ◆ Error in dyeing process 	<ul style="list-style-type: none"> ◆ Lab dyeing before production
 <p>Colour non-uniformity</p>	<ul style="list-style-type: none"> ◆ Error in dyeing process 	<ul style="list-style-type: none"> ◆ Respect of dyeing process

CLEANING AND WASTE DISPOSAL

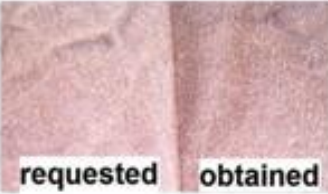
- Clean the wastes around the machine
- Segregate the wastes collected and deposit at the waste bins
- Remove the defect in cones / chesses.
- Use proper tools for cleaning as instructed by superiors
- Carryout cleaning activities in creeling zone, knitting zone, and fabric zone.
- Ensure the yarn paths, eyelets, knitting heads, machines, and working environment are clean and free of contamination in accordance with workplace procedures.
- Ensure safety while carrying out cleaning
- Ensure the wastes collected are deposited in the respective waste box
- Ensure knitting machine area is clean

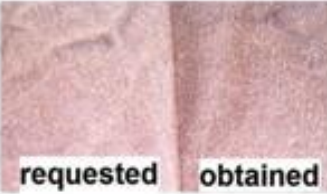
SHIFT INTERCHANGE

TAKING CHARGE OF SHIFT

- Reach atleast 10 - 15 minutes early to the work place
- Bring the necessary operational tools to the department
- Discuss with the previous shift operator and collect the information regarding the count, process, issues faced in quality, current fabric production followed in the knitting department.
- Discuss about current order running for which company.
- Ensure the proper functioning of machine and problems if any should be reported to the supervisor and maintenance in- charge.
- Discuss about the current order quantity and balance quantity.
- Discuss about the new order fabric details and quantity.
- Discuss about the department cleanliness.

HANDING OVER AT SHIFT END

- Clean the machine and department before handing over the shift.
- Hand over the necessary operational tools if any.
- Discuss with the next shift operator and give the information regarding the count, gsm, loop length, process, issues faced in quality, and current fabric production followed in the knitting department.
- Discuss about current order running for which company.
- Note the production details for the current shift
- Ensure the proper functioning of machine and problems if any should be reported to the supervisor and maintenance in- charge.
- Should discuss with next operator about the current order
- Quality, quantity and balance quantity.
- Discuss about the new order fabric details and quantity.
- Discuss about the department cleanliness.

HEALTH & SAFETY

- Comply with health and safety related instructions applicable to the workplace
- Use and maintain personal protective equipment such as “ ear plug”, “ nose mask “ “ head cap” etc., as per protocol
- Maintain personal hygiene and dress code.
- Carry out own activities in line with approved guidelines and procedures
- Report any service malfunctions to supervisor
- Store materials and equipment in line with organisational requirements
- Safely handle and remove waste
- Minimize health and safety risks to self and others due to own actions
- Seek clarifications, from supervisors or other authorized personnel in case of perceived risks
- Monitor the workplace and work processes for potential risks and threat
- Carry out periodic walk-through to keep work area free from hazards and obstructions, if assigned
- Participate in mock drills / evacuation procedures organized at the workplace
- Take action based on instructions in the event of fire, emergencies or accidents and report to supervisor.
- Do not stack Yarns in front of Fire Extinguishers/ First Aid Box and passages.
- Do not keep the door of Machine room open while machine is in operation